

ÜRÜN KATALOĐU
OCAK 2026



KSN[®]

Kaliteyi Seęme Nedeniniz...

konsangroup.com

KSN[®]

EDE[®]
KONDANSATÖR
CAPACITOR



W
沃尔
SHENZHEN WOER HEAT
SHRINKABLE MATERIAL CO., LTD.
FİRMA ÜRETİMİDİR
"İSİ İLE DARALAN MAKARON"

HAWCON[®]
KONDANSATÖR

JURKAB[®]

KSN[®]

MAKİNA BAĞLANTI ELEMANLARI
SANAYİ VE TİC. LTD. ŞTİ.



Kaliteyi Seçme Nedeniniz...

Tarihçemiz;

Firmamız, Őenol KONAN tarafından **Konsan Elektroteknik Sanayi ve Tic. Ltd. Őti.** olarak Ocak 1994 yılında İstanbul Beyođlu (Karaköy) ilçesinde ticari faaliyetine başlamıŐ ve istikrarlı bir Őekilde büyüyerek ve geliŐerek bugüne kadar gelmiŐtir.

Ticaret hayatına "Aile Őirketi" olarak, Karaköy, Perpa ve İmes Őubeleri ile devam etmektedir.

Misyonumuz;

KSN "Kaliteyi Seçme Nedeniniz" sloganı ile Türkiye pazarında kendini kanıtlamıŐtır. Markalarımız olan **KONSAN, KSN, HAWCON, JURKAB** ve **EDE KONDANSATÖR** ile bugünlere gelmiŐ ve uzakdođu ülkeleriyle uzun yıllara dayanan ticari iŐbirlikleriyle, Sektörümüzde birçok markanın ana bayiliđini en iyi Őekilde yapmaktadır.

Vizyonumuz;

KONAN Ailesinin sektörde oluŐturduđu tarihsel güveni, ticari baŐarısı ve yenilikçi anlayıŐıyla geleceđe taŐıyan, öncelikli amacı sektörün talep ve ihtiyaçlarını karŐılayacak dođru adımları atarak en kaliteli ürünleri **Rasyonel Fiyat** ve **Maksimum Hizmet** politikasıyla, pazarda ülke ekonomisine fayda sađlamayı kendine hedef olarak belirlemiŐtir.

Firmamız uluslararası kalite standartları olan **ISO-9001** ve **CE** belgelerini almıŐtır.



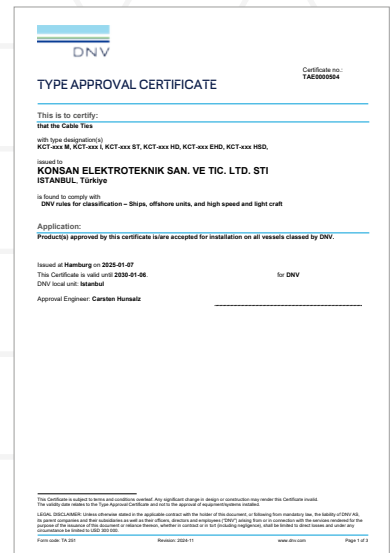

MAKARON GRUBU**08**

- Siyah Isı ile Daralan Makaronlar
- Renkli Isı ile Daralan Makaronlar
- 3/1 İç Yapışkanlı Isı ile Daralan Makaron SBRSM-NF
- 3/1 İç Yapışkanlı Isı ile Daralan Makaron (Rulo)
- Kablo Toplama Çorapları
- Metal Kablo Çekme Çorabı
- H - CLASS Silikonlu Makaronlar
- Cam Elyaf Makaronlar
- Renkli Cam Elyaf Makaronlar

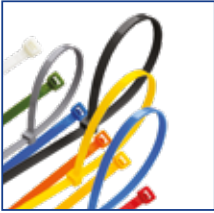
KABLO BAĞLARI VE AKSESUARLAR**20**

- Beyaz / Siyah / Renkli Kablo Bağları
- Etiketli Beyaz Kablo Bağları
- Panele Kafadan Sıkışan Beyaz Kablo Bağları
- Açılabilir Beyaz Kablo Bağları
- 304 Paslanmaz Çelik Kablo Bağları ve Etiket
- 304 Paslanmaz Çelik Polyester Kaplı Kablo Bağları
- Tırnaklı Kablo Bağı
- Yapışkanlı Kroşeler
- Vidalı Kroşeler
- Yapışkanlı Kablo Tutucu
- Kablo Klipsi
- Dübel Kroşe
- Baskılı Devre Taşıyıcıları
- Yapışkanlı Bükülebilir Klips
- Kablo Bağı Etiket Taşıyıcı
- Yapışkan Pano Etiketi
- Kapama Parçası Helezon Kablo Spiralleri
- EC Tipi Kablo İşaretleme

KABLO YÜKSÜKLERİ VE PABUÇLARI**31**

- İzoleli Tek Giriş Yüksükler (Fransız/Alman Normu)
- İzoleli Çift Giriş Yüksükler (Fransız/Alman Normu)
- İzoleli Kablo Yüksükleri
- Yuvarlak Tip İzoleli Kablo Uçları
- Çatal Tip İzoleli Kablo Uçları
- Dişi Faston Tip İzoleli
- Dişi Faston Tip Tam İzoleli
- Dişi Faston Tip Tam İzoleli Polyamid Kablo Uçları
- Erkek Faston Tip İzoleli
- Erkek/Dişi Geri Dönüştürülebilir İzoleli
- Bayrak Tip Tam İzoleli Polyamid Kablo Uçları
- İzoleli Erkek Terminaler
- İzoleli Dişi Terminaler
- İzoleli Kablo Ucu Ek Mufları
- İğne Tip İzoleli
- Bıçak Tip İzoleli
- Ucu Kıvrık Bıçak Tip İzoleli Kablo Uçları
- Isı Büzüşmeli Ek Muf
- Vidalı Buat Klemensleri
- Hızlı Kablo Ekleme Parçası
- Standart Tip Sıkmalı Kablo Pabuçları
- Eko Tip Sıkmalı Kablo Pabuçları
- Eko Tip Ek Muflar
- Kaynaklı Tip Sıkmalı Kablo Pabuçları

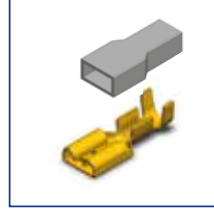
İZOLESİZ KABLO UÇLARI VE KONNEKTÖRLERİ**50**

- İzoleli Kablo Uçları ve Konnektörler

Ø22 BUTON GRUBU & LED SİNYALLER**54**

- Yaylı Butonlar
- Işıklı Yaylı Butonlar
- Kalıcı Mandal Butonlar
- Kayıcı Mandal Butonlar
- Anahtarlı Kalıcı Butonlar
- Işıklı Kalıcı Mandal Butonlar
- Yardımcı Kontaklar
- Kalıcı Mantar Buton
- Kalıcı Anahtarlı Mantar Buton
- Kayıcı Mantar Buton
- İkiz Buton
- Led Sinyaller
- Led'li Buzzer
- Voltmetre
- Ampermetre
- Potansiyometre
- Motorlu Siren
- Köprü Diyot
- ST Serisi Termik Sigorta

DAĞITICI ÜNİTELER & KOMPAKT ÇOK AMAÇLI KLEMENSLER**64**

- 2 Kutuplu Dağıtıcı Üniteler
- 4 Kutuplu Dağıtıcı Üniteler
- W Otomat Rayı
- Trifaze Müşterek W Otomat Baraları
- Monofaze Müşterek W Otomat Baraları
- Nötr Vidalı Topraklama Baraları
- Pano İç Termostatlar
- Universal Sayıcılar
- Kompakt Çok Amaçlı Klemensler
- Tek Damar İletkenler İçin Buat Klemensler
- 221 Serisi Kompakt Çok Amaçlı Klemensler
- Aydınlatma için Kablo Klemensler

EL ALETLERİ GRUBU**70**

- Mekanik El Aletleri
- Kablo Soyma ve Kesme Aletleri
- Network Penseleri
- Kablo Bağı Sıkma Penseleri
- Mekanik SKP Papuç Sıkma Penseleri
- Hidrolik Papuç Sıkma Penseleri
- Unior Kontrol Kalemi ve Penseler
- İzletiş Kontrol Kalemi
- Knipex El Aletleri

KONDANSATÖR GRUBU

80



HAWCON & EDE

- Daimi Devre Motor ve Aydınlatma Kondansatörleri
- Daimi Devre Motor Kondans. Plastik Tüp Vidali, Term.
- Motor İlk Hareket (Start) Kondansatörleri
- Fan Kondansatörleri Kare Tip (400 - 450 V)
- Daimi Devre Motor Kondans. Alüm. Tüp, Vidali, Term.

KONDAŞ

- Standart Kutu Tip Güç Kondansatörleri
- Standart Silindirik Tip Güç Kondansatörleri

LEHİM TELLERİ VE HAVYA GRUBU

87



- Lehim Telleri
- Lehim Suyu Flux
- Lehim Pastaları
- WELLER Havya Grubu
- ER-SA Kalem ve Çekiç Havyalar
- UPX Set Havya
- CLASS Havya Grubu
- SOLOMON Set ve Kalem Havyalar
- SONAR Tabanca Havya

ÖLÇÜ ALETLERİ

95



- UNI-T Ölçü Aletleri
- Diğer Ölçü Aletleri

DAĞITICI ÜNİTELER

- 2 Kutuplu Dağıtıcı Üniteler
- 4 Kutuplu Dağıtıcı Üniteler



YENİ İTHALATIMIZ ***

BANT, SPREY VE SICAK HAVA TABANICALARI

99



- KSN Eriyen Bantlar
- Globe İzole Bantlar
- Çift Taraflı Bantlar
- Coroplast Tüylü ve Tüysüz Bez Bantlar
- Teflon Bantlar
- STEINEL Sıcak Hava Tabancaları ve Aksesuarları
- CARTELL Silikon Tabancaları ve Mum Silikonlar
- HAWCON Sprey Çeşitleri
- Perfects Sprey Çeşitleri

ANAHTAR VE SWITCH GRUBU

103



- Yerli Anahtar ve Switch Çeşitleri
- İthal Anahtar ve Switch Çeşitleri
- Born Klemens Banan Fiş Ve Krokodil Çeşitleri
- Fuse Yuva ve Cam Sigortalar

Ø22 BUTON GRUBU & LED SİNYALLER

- Yaylı Butonlar
- Işıklı Yaylı Butonlar
- Kalıcı Mandal Butonlar
- Kayıcı Mandal Butonlar
- Anahtarlı Kalıcı Butonlar
- Işıklı Kalıcı Mandal Butonlar
- Yardımcı Kontaklar
- Kalıcı Mantar Buton
- Kalıcı Anahtarlı Mantar Buton
- Kayıcı Mantar Buton
- İkiz Buton
- Led Sinyaller
- Led'li Buzzer
- Voltmetre
- Ampermetre
- Potansiyometre
- Motorlu Siren
- Köprü Diyot
- ST Serisi Termik Sigorta



YENİ İTHALATIMIZ ***



www.konsangroup.com

MAKARON GRUBU



沃尔

SHENZHEN WOER HEAT
SHRINKABLE MATERIAL CO., LTD.
FİRMA ÜRETİMİDİR
“İSİ İLE DARALAN MAKARON”

KSN®

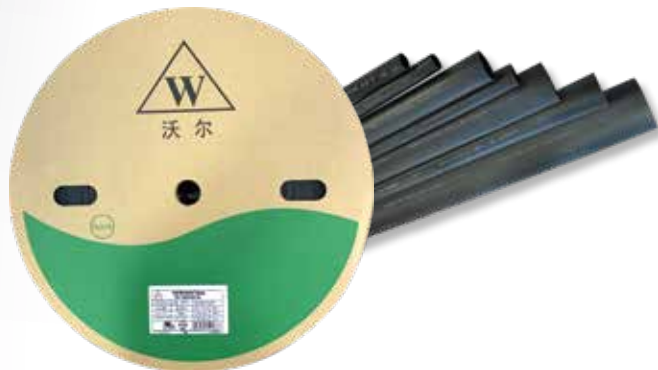

SİYAH ISI İLE DARALAN MAKARONLAR

İTHALATIMIZ



ÜRÜN KODU	Ölçüler		Daralmadan Önce (mm)		Daralmadan Sonra (mm)		Makara (m)	Koli Mik. (m)	Metre Fiyatı (\$)
	inc	mm							
DRM-S-0001	-	0,8	1,1 ± 0,2	0,15 ± 0,05	0,50	0,28 ± 0,10	200	4.600	0,165 \$
DRM-S-0002	-	1	1,5 ± 0,2	0,15 ± 0,05	0,50	0,28 ± 0,10	200	3.200	0,090 \$
DRM-S-0003	-	1,2	2,0 ± 0,2	0,15 ± 0,05	0,70	0,30 ± 0,10	200	3.000	0,090 \$
DRM-S-0004	-	1,5	2,0 ± 0,2	0,18 ± 0,05	0,85	0,32 ± 0,10	200	2.400	0,097 \$
DRM-S-0005	1/16	1,6	2,0 ± 0,3	0,15 ± 0,05	0,80	0,28 ± 0,10	200	3.200	0,104 \$
DRM-S-0006	-	2	2,5 ± 0,2	0,18 ± 0,05	0,60	0,28 ± 0,10	200	3.000	0,115 \$
DRM-S-0007	3/32	2,4	3,0 ± 0,3	0,18 ± 0,05	1,20	0,35 ± 0,10	200	3.000	0,115 \$
DRM-S-0007A	-	2,5	3,0 ± 0,2	0,18 ± 0,05	1,30	0,38 ± 0,10	200	2.600	0,150 \$
DRM-S-0008	-	3	3,5 ± 0,2	0,18 ± 0,05	1,50	0,40 ± 0,10	200	2.200	0,160 \$
DRM-S-0009	1/8	3,2	3,5 ± 0,4	0,18 ± 0,05	1,60	0,40 ± 0,10	200	2.200	0,160 \$
DRM-S-0010	-	3,5	4,0 ± 0,2	0,22 ± 0,05	1,80	0,42 ± 0,10	200	1.800	0,170 \$
DRM-S-0011	-	4	4,5 ± 0,2	0,25 ± 0,05	2,00	0,45 ± 0,10	200	1.400	0,200 \$
DRM-S-0012	-	4,5	5,0 ± 0,2	0,25 ± 0,05	2,30	0,50 ± 0,10	100	1.000	0,230 \$
DRM-S-0013	3/16	4,8	5,2 ± 0,4	0,25 ± 0,05	2,40	0,50 ± 0,10	100	1.000	0,230 \$
DRM-S-0014	-	5	5,5 ± 0,2	0,25 ± 0,05	2,50	0,55 ± 0,10	100	900	0,250 \$
DRM-S-0015	-	6	6,5 ± 0,2	0,28 ± 0,05	3,00	0,55 ± 0,10	100	700	0,290 \$
DRM-S-0016	1/4	6,4	7,0 ± 0,4	0,28 ± 0,05	3,20	0,55 ± 0,10	100	700	0,290 \$
DRM-S-0017A	-	7 YASSI	7,5 ± 0,3	0,28 ± 0,05	3,50	0,55 ± 0,10	100	1.400	0,340 \$
DRM-S-0017	-	7 BORU	7,5 ± 0,3	0,28 ± 0,05	3,50	0,55 ± 0,10	100	500	0,368 \$
DRM-S-0018A	-	8 YASSI	8,5 ± 0,3	0,28 ± 0,05	4,00	0,60 ± 0,10	100	1.300	0,345 \$
DRM-S-0018	-	8 BORU	8,5 ± 0,3	0,28 ± 0,05	4,00	0,60 ± 0,10	100	500	0,397 \$
DRM-S-0019A	-	9 YASSI	9,5 ± 0,3	0,30 ± 0,08	4,50	0,60 ± 0,10	100	1.200	0,350 \$
DRM-S-0019	-	9 BORU	9,5 ± 0,3	0,30 ± 0,08	4,50	0,60 ± 0,10	50	300	0,450 \$
DRM-S-0020	3/8	9,5	10,0 ± 0,5	0,30 ± 0,08	4,80	0,60 ± 0,10	100	1.200	0,350 \$
DRM-S-0021	-	10	10,5 ± 0,3	0,30 ± 0,08	5,00	0,60 ± 0,10	100	1.100	0,390 \$
DRM-S-0022	-	11	11,5 ± 0,3	0,30 ± 0,08	5,50	0,60 ± 0,10	100	1.100	0,442 \$

TEKNİK ÖZELLİKLER

Malzeme:

Polyolefin

Daralma Oranı: 2/1

Yanmazlık:

Kendi kendine söner

Çalışma Sıcaklığı:

-55 °C + 125 °C (600V)



SIYAH ISI İLE DARALAN MAKARONLAR

İTHALATIMIZ



TEKNİK ÖZELLİKLER

Malzeme:

Polyolefin

Daralma Oranı: 2/1

Yanmazlık:

Kendi kendine söner

Çalışma Sıcaklığı:

-55 °C + 125 °C (600V)



ÜRÜN KODU	Ölçüler		Daralmadan Önce (mm)		Daralmadan Sonra (mm)		Makara (m)	Koli Mik. (m)	Metre Fiyatı (\$)
	inc	mm							
DRM-S-0023	-	12	12,5 ± 0,3	0,30 ± 0,08	6,00	0,60 ± 0,10	100	1.000	0,450 \$
DRM-S-0024	1/2	12,7	13,0 ± 0,5	0,30 ± 0,08	6,40	0,60 ± 0,10	100	1.000	0,450 \$
DRM-S-0025	-	13	13,5 ± 0,3	0,35 ± 0,10	6,50	0,65 ± 0,10	100	900	0,480 \$
DRM-S-0026	-	14	14,5 ± 0,3	0,35 ± 0,10	7,00	0,65 ± 0,10	100	900	0,570 \$
DRM-S-0027	-	15	15,5 ± 0,3	0,35 ± 0,10	7,00	0,65 ± 0,10	100	800	0,675 \$
DRM-S-0028	-	16	15,5 ± 0,3	0,35 ± 0,10	7,00	0,65 ± 0,10	100	800	0,750 \$
DRM-S-0029	-	17	16,5 ± 0,4	0,40 ± 0,12	8,00	0,70 ± 0,10	100	700	0,975 \$
DRM-S-0030	-	18	17,5 ± 0,4	0,40 ± 0,15	8,50	0,80 ± 0,15	100	700	0,980 \$
DRM-S-0031	3/4	19,1	19,0 ± 0,5	0,40 ± 0,15	9,00	0,80 ± 0,15	100	700	0,980 \$
DRM-S-0032	4/5	20	20,5 ± 0,6	0,40 ± 0,15	9,50	0,80 ± 0,15	100	600	1,250 \$
DRM-S-0033	-	22	21,0 ± 0,6	0,40 ± 0,15	10,00	0,80 ± 0,15	100	600	1,550 \$
DRM-S-0034	1	25,4	23,0 ± 0,5	0,40 ± 0,15	11,00	0,80 ± 0,15	50	300	1,650 \$
DRM-S-0035	-	30	25,6 ± 0,7	0,50 ± 0,15	12,70	0,80 ± 0,15	50	250	2,150 \$
DRM-S-0036	1-1/4	32	31,5 ± 1,0	0,50 ± 0,15	15,00	0,95 ± 0,15	50	250	2,150 \$
DRM-S-0037	-	35	33,0 ± 0,7	0,50 ± 0,15	15,50	0,95 ± 0,15	50	200	2,720 \$
DRM-S-0038	1-1/2	38	36,5 ± 1,0	0,50 ± 0,15	17,50	0,90 ± 0,15	50	200	3,000 \$
DRM-S-0039	-	40	40,0 ± 0,7	0,50 ± 0,15	19,10	1,00 ± 0,15	50	200	3,000 \$
DRM-S-0040	2	51	41,5 ± 1,0	0,55 ± 0,15	20,00	1,00 ± 0,15	25	125	3,800 \$
DRM-S-0041	-	60	52,5 ± 0,7	0,55 ± 0,15	25,40	0,95 ± 0,15	25	100	5,100 \$
DRM-S-0042	-	70	60	0,65 ± 0,15	30,00	1,30 ± 0,20	25	75	6,850 \$
DRM-S-0043	3	76	70	0,65 ± 0,15	35,00	1,30 ± 0,20	25	75	7,500 \$
DRM-S-0044	-	80	80,0 ± 1,0	0,65 ± 0,15	38,10	1,30 ± 0,20	25	75	7,500 \$
DRM-S-0045	-	90	80	0,65 ± 0,15	40,00	1,46 ± 0,20	25	50	8,500 \$
DRM-S-0046	4	102	90	0,65 ± 0,15	45,00	1,46 ± 0,20	25	50	9,500 \$
DRM-S-0047	5	120	105,0 ± 1,0	0,65 ± 0,20	50,80	1,46 ± 0,20	25	50	13,000 \$
DRM-S-0048	-	150	120	0,65 ± 0,20	63,50	1,56 ± 0,20	25	50	20,000 \$
DRM-S-0049	-	180	150	0,65 ± 0,20	75,00	1,56 ± 0,20	25	25	28,000 \$

RENKLİ ISI İLE DARALAN MAKARONLAR

İTHALATIMIZ

BEYAZ

ŞEFFAF

MAVİ

YEŞİL

KIRMIZI

SARI

GRİ

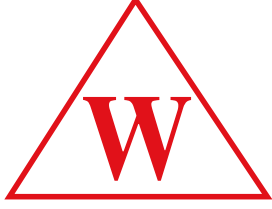

沃尔

 SHENZHEN WOER HEAT
SHRINKABLE MATERIAL CO., LTD.

FIRMA ÜRETİMİDİR

"ISI İLE DARALAN MAKARON"



Ölçüler		Makara (m)	Koli Miktarı (m)	Metre Fiyatı (\$)
Inc	mm			
1/16	1,6	200	3.200	0,110 \$
-	2	200	3.000	0,140 \$
3/32	2,4	200	3.000	0,140 \$
-	2,5	200	2.600	0,165 \$
1/8	3,2 (Yassı)	100	1.700	0,220 \$
1/8	3,2 (Boru)	200	2.200	0,190 \$
-	3,5 (Yassı)	100	1.700	0,230 \$
-	3,5 (Boru)	200	1.800	0,210 \$
3/16	4,8 (Yassı)	100	1.600	0,300 \$
3/16	4,8 (Boru)	100	1.000	0,260 \$
-	5	100	900	0,320 \$
1/4	6,4 (Yassı)	100	1.500	0,380 \$
1/4	6,4 (Boru)	100	700	0,330 \$
-	7 (Yassı)	100	1.400	0,340 \$
3/8	9,5	100	1.200	0,400 \$
1/2	12,7	100	1.000	0,530 \$
-	16	100	800	0,860 \$
3/4	19,1	100	700	1,380 \$
4/5	20	100	600	1,500 \$
1	25,4	50	300	1,860 \$
1-1/4	32	50	250	2,400 \$
-	35	50	200	3,300 \$
1-1/2	38	50	200	3,500 \$
2	51	25	125	4,200 \$
-	60	25	100	6,000 \$
-	70	25	75	7,500 \$
3	76	25	75	8,300 \$
-	80	25	75	8,300 \$
4	102	25	50	12,000 \$
5	120	25	50	18,000 \$
	150	25	50	30,00 \$
	180	25	25	45,00 \$

TEKNİK ÖZELLİKLER

Malzeme:

Polyolefin

Daralma Oranı: 2/1

Yanmazlık:

Kendi kendine söner

Çalışma Sıcaklığı:

-55 °C + 125 °C (600V)



RENKLİ ISI İLE DARALAN MAKARONLAR

İTHALATIMIZ

SARI

YEŞİL



沃尔

SHENZHEN WOER HEAT
SHRINKABLE MATERIAL CO., LTD.
FİRMA ÜRETİMİDİR

“ISI İLE DARALAN MAKARON”



Ölçüler		Makara (m)	Koli Miktarı (m)	Metre Fiyatı (\$)
Inc	mm			
1/16	1,6	200	3.200	0,64 \$
3/32	2,4	200	3.000	0,42 \$
1/8	3,2	200	2.200	0,43 \$
3/16	4,8	100	1.000	0,44 \$
1/4	6,4	100	700	0,50 \$
3/8	9,5	100	1.200	0,68 \$
1/2	12,7	100	1.000	0,95 \$
-	16	100	800	1,45 \$
3/4	19,1	100	700	1,70 \$
4/5	20	100	600	1,88 \$
1	25,4	50	300	2,75 \$
1-1/4	32	50	250	3,70 \$
1-1/2	38	50	200	5,00 \$
2	51	25	125	7,00 \$
-	60	25	100	10,20 \$
3	76	25	75	16,00 \$
-	80	25	75	16,00 \$
4	102	25	50	25,00 \$

KAHVERENGİ

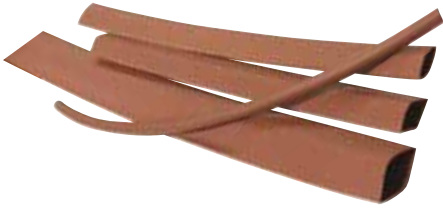

Ölçüler		Makara (m)	Koli Miktarı (m)	Metre Fiyatı (\$)
Inc	mm			
3/32	2,4	200	3.000	0,15 \$
1/8	3,2	200	2.200	0,22 \$
3/16	4,8	100	1.000	0,29 \$
1/4	6,4	100	700	0,37 \$
3/8	9,5	100	1.200	0,45 \$
1/2	12,7	100	1.000	0,58 \$
-	16	100	800	1,00 \$
3/4	19,1	100	700	1,40 \$
4/5	20	100	600	1,57 \$
1	25,4	50	300	2,10 \$
1-1/4	32	50	250	2,75 \$
-	35	50	200	3,90 \$
1-1/2	38	50	200	4,00 \$
2	51	25	125	5,00 \$
-	60	25	100	7,40 \$
-	70	25	75	8,50 \$
3	76	25	75	9,00 \$
-	80	25	75	9,00 \$
4	102	25	50	13,40 \$
5	120	25	50	19,00 \$
-	150	25	50	35,00 \$
-	180	25	25	50,00 \$

TEKNİK ÖZELLİKLER

Malzeme:

Polyolefin

Daralma Oranı: 2/1

Yanmazlık:

Kendi kendine söner

Çalışma Sıcaklığı:

-55 °C + 125 °C (600V)



3/1 İÇİ YAPIŞKANLI ISI İLE DARALAN MAKARON SBRSM-NF

İTHALATIMIZ

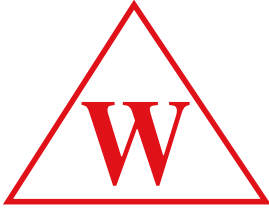

沃尔

SHENZHEN WOER HEAT
SHRINKABLE MATERIAL CO., LTD.
FİRMA ÜRETİMİDİR

"ISI İLE DARALAN MAKARON"



TEKNİK ÖZELLİKLER

Malzeme:

Polyolefin

Daralma Oranı: 3/1

Yanmazlık:

Kendi kendine söner

Çalışma Sıcaklığı:

-55 °C + 125 °C

Ölçü (mm)	Daralmadan Sonra (mm)				Boy (m)	Koli Miktarı (Adet)	Metre Fiyatı (\$)
	Çap	Cidar Kalınlığı	Yapışkan Katmanı	Toplam Cidar Kalınlığı			
6	2	1,40 ± 0,20	0,45 ± 0,10	1,85 ± 0,25	1.22 m	400	1,25 \$
9	3	1,40 ± 0,20	0,50 ± 0,10	1,90 ± 0,25	1.22 m	200	1,70 \$
12	3	1,40 ± 0,20	0,50 ± 0,10	1,90 ± 0,25	1.22 m	150	2,25 \$
16	5	1,50 ± 0,20	0,55 ± 0,15	2,15 ± 0,30	1.22 m	200	3,20 \$
19,1	5,6	1,80 ± 0,20	0,60 ± 0,15	2,40 ± 0,30	1.22 m	150	4,40 \$
22	6	2,00 ± 0,30	0,60 ± 0,15	2,60 ± 0,30	1.22 m	100	4,50 \$
25	8	2,00 ± 0,30	0,60 ± 0,15	2,70 ± 0,30	1.22 m	90	4,80 \$
28	6	2,40 ± 0,30	0,95 ± 0,20	3,30 ± 0,35	1.22 m	75	5,10 \$
33	8	2,50 ± 0,30	0,80 ± 0,15	3,30 ± 0,35	1.22 m	50	5,70 \$
38,1	12	2,40 ± 0,30	0,80 ± 0,15	3,30 ± 0,35	1.22 m	40	6,30 \$
43,2	12,7	2,50 ± 0,30	0,80 ± 0,15	3,30 ± 0,35	1.22 m	35	7,10 \$
56	16	2,50 ± 0,30	0,80 ± 0,15	3,30 ± 0,35	1.22 m	25	8,00 \$
65	19	2,50 ± 0,30	0,80 ± 0,25	3,30 ± 0,45	1.22 m	25	9,10 \$
75	22	2,90 ± 0,30	0,80 ± 0,15	3,70 ± 0,40	1.22 m	25	11,30 \$
95	30	3,00 ± 0,30	0,80 ± 0,15	3,80 ± 0,40	1.22 m	20	16,00 \$
115	34	3,00 ± 0,30	0,80 ± 0,15	3,80 ± 0,40	1.22 m	20	19,00 \$
140	42	3,00 ± 0,30	0,80 ± 0,15	3,80 ± 0,40	1.22 m	20	25,00 \$
180	65	3,10 ± 0,30	0,80 ± 0,15	3,90 ± 0,40	1.22 m	15	38,00 \$
200	69	3,10 ± 0,30	0,80 ± 0,15	3,90 ± 0,40	1.22 m	15	54,00 \$

3/1 İÇİ YAPIŞKANLI ISI İLE DARALAN MAKARON (RULO)

İTHALATIMIZ



Ölçü		Daralmadan Önce (mm)	Daralmadan Sonra (mm)			Rulo (m)	Koli Miktarı (m)	Metre Fiyatı (\$)
Inc	mm	İç Çap (mm)	İç Çap (mm)	Yapışkan Katmanı	Cidar Kalınlığı			
1/8	3,2	3,2	1,00	0,40 ± 0,10	0,95 ± 0,15	200	1.800	0,65 \$
3/16	4,8	4,8	1,60	0,40 ± 0,10	1,10 ± 0,15	100	900	0,80 \$
1/4	6,4	6,4	2,20	0,45 ± 0,12	1,20 ± 0,15	100	600	1,20 \$
3/8	9,5	9,5	3,20	0,50 ± 0,12	1,45 ± 0,20	50	300	1,60 \$
1/2	12,7	12,7	4,20	0,50 ± 0,12	1,70 ± 0,20	25	250	2,20 \$
5/8	16	16	5,20	0,55 ± 0,15	1,80 ± 0,20	25	225	2,85 \$
3/4	19,1	19,1	6,30	0,55 ± 0,15	2,00 ± 0,20	25	175	3,45 \$
1	25,4	25,4	8,50	0,55 ± 0,15	2,10 ± 0,25	25	150	4,60 \$

MAKARON SETİ (328 PARÇA)



ÜRÜN KODU	CİNSİ	FİYATI \$/ Ad.
HWA-274/1	Isı ile Daralan Makaron 328 Parça, 8 Boy, 5 Renk	3,80 \$

MAKARON SETİ (530 PARÇA)



ÜRÜN KODU	CİNSİ	FİYATI \$/ Ad.
HWA-274/2	Isı ile Daralan Makaron 530 Parça, 12 Boy, 5 Renk	4,50 \$

MAKARON SETİ (750 PARÇA)



ÜRÜN KODU	CİNSİ	FİYATI \$/ Ad.
HWA-274/3	Isı ile Daralan Makaron 750 Parça, 12 Boy, 5 Renk	5,50 \$

LEHİMLİ MAKARON SETİ (100 PARÇA)



ÜRÜN KODU	CİNSİ	FİYATI \$/ Ad.
HWA-274S	Lehimli Makaron 100 Parça, 4 Boy, 4 Renk	9,00 \$

KSN® KABLO TOPLAMA ÇORAPLARI

İTHALATIMIZ

ÜRÜN KODU	CİNSİ	Genişleme Aralığı		METRE	MT/FİYAT (\$)
		Min.	Max.		
KSN-03	3 mm Kablo Toplama Çorabı / Siyah	1	6	100	0,24 \$
KSN-04	4 mm Kablo Toplama Çorabı / Siyah	2	7	100	0,26 \$
KSN-05	5 mm Kablo Toplama Çorabı / Siyah	3	9	100	0,27 \$
KSN-06	6 mm Kablo Toplama Çorabı / Siyah	3	9	100	0,28 \$
KSN-08	8 mm Kablo Toplama Çorabı / Siyah	5	16	100	0,30 \$
KSN-10	10 mm Kablo Toplama Çorabı / Siyah	7	19	100	0,36 \$
KSN-12	12 mm Kablo Toplama Çorabı / Siyah	8	24	100	0,43 \$
KSN-15	15 mm Kablo Toplama Çorabı / Siyah	10	27	100	0,48 \$
KSN-20	20 mm Kablo Toplama Çorabı / Siyah	14	30	100	0,56 \$
KSN-25	25 mm Kablo Toplama Çorabı / Siyah	18	35	100	0,72 \$
KSN-30	30 mm Kablo Toplama Çorabı / Siyah	20	50	50	0,87 \$
KSN-40	40 mm Kablo Toplama Çorabı / Siyah	30	60	50	1,40 \$
KSN-50	50 mm Kablo Toplama Çorabı / Siyah	40	80	50	1,87 \$
KSN-70	70 mm Kablo Toplama Çorabı / Siyah	64	120	50	3,50 \$
KD-8-3	CUTTER Kablo Çorabı Kesme Aleti			1 Adet	290,00 \$
KD-8-3-Y	CUTTER Kablo Çorabı Kesme Yedek Bıçağı			1 Adet	30,00 \$



KSN® METAL KABLO ÇEKME ÇORABI

İTHALATIMIZ



ÇAP (mm)	SIKMA ÇAP	BOY (cm)	KAPASİTE	ÇİFT ASKI TİP ADET / (₺)	TEK ASKI TİP ADET / (₺)
10	5 - 12	60	800 kg	950,00 ₺	800,00 ₺
20	11 - 20	80	1,000 kg	1.050,00 ₺	900,00 ₺
30	21 - 30	90	1,500 kg	1.200,00 ₺	1.025,00 ₺
40	31 - 40	100	2,000 kg	1.300,00 ₺	1.100,00 ₺
60	41 - 60	130	2,500 kg	1.600,00 ₺	1.450,00 ₺
80	61 - 80	150	3,500 kg	1.800,00 ₺	1.650,00 ₺
100	81 - 100	165	4,000 kg	2.425,00 ₺	2.050,00 ₺
120	101 - 120	175	4,500 kg	2.750,00 ₺	2.275,00 ₺
140	121 - 140	180	5,000 kg	3.750,00 ₺	3.300,00 ₺



KSN®
H - CLASS MAKARON

TEKNİK ÖZELLİKLER
Malzeme:

Silikon İzoleli Cam Elyaf
Örgü Makaron

Çalışma Sıcaklığı:

-60 °C + 250 °C



ÜRÜN KODU	CİNSİ		RULO (m)	KOLİ MİKTARI (m)	FİYAT (\$) (m)
SRG-1,0	1 mm	H - Class Makaron 2,5 KV	100	1.500	0,290 \$
SRG-1,5	1,5 mm	H - Class Makaron 2,5 KV	100	1.500	0,315 \$
SRG-2,0	2 mm	H - Class Makaron 2,5 KV	100	1.000	0,320 \$
SRG-2,5	2,5 mm	H - Class Makaron 2,5 KV	100	1.000	0,340 \$
SRG-3,0	3 mm	H - Class Makaron 2,5 KV	100	600	0,350 \$
SRG-4,0	4 mm	H - Class Makaron 2,5 KV	100	500	0,470 \$
SRG-5,0	5 mm	H - Class Makaron 2,5 KV	100	500	0,570 \$
SRG-6,0	6 mm	H - Class Makaron 2,5 KV	100	500	0,690 \$
SRG-7,0	7 mm	H - Class Makaron 2,5 KV	100	500	0,800 \$
SRG-8,0	8 mm	H - Class Makaron 2,5 KV	100	400	1,040 \$
SRG-10,0	10 mm	H - Class Makaron 2,5 KV	100	400	1,260 \$
SRG-12,0	12 mm	H - Class Makaron 2,5 KV	50	250	1,580 \$
SRG-14,0	14 mm	H - Class Makaron 2,5 KV	50	250	1,890 \$
SRG-16,0	16 mm	H - Class Makaron 2,5 KV	50	200	2,520 \$
SRG-18,0	18 mm	H - Class Makaron 2,5 KV	50	200	3,250 \$
SRG-20,0	20 mm	H - Class Makaron 2,5 KV	50	200	4,200 \$
SRG-25,0	25 mm	H - Class Makaron 2,5 KV	25	125	8,000 \$
SRG-30,0	30 mm	H - Class Makaron 2,5 KV	25	100	11,800 \$
SRG-35,0	35 mm	H - Class Makaron 2,5 KV	25	100	13,800 \$
SRG-40,0	40 mm	H - Class Makaron 2,5 KV	25	100	21,000 \$
SRG-50,0	50 mm	H - Class Makaron 2,5 KV	25	75	45,150 \$

KSN® H - CLASS SİLİKONLU MAKARONLAR

İTHALATIMIZ

ÜRÜN KODU	CİNSİ		RULO (m)	KOLİ MİKTARI (m)	FİYAT (\$) (m)
SRG-1,0	1 mm	H - Class Makaron 1,5 KV	100	1.500	
SRG-1,5	1,5 mm	H - Class Makaron 1,5 KV	100	1.500	
SRG-2,0	2 mm	H - Class Makaron 1,5 KV	100	1.000	
SRG-2,5	2,5 mm	H - Class Makaron 1,5 KV	100	1.000	
SRG-3,0	3 mm	H - Class Makaron 1,5 KV	100	600	
SRG-4,0	4 mm	H - Class Makaron 1,5 KV	100	500	
SRG-5,0	5 mm	H - Class Makaron 1,5 KV	100	500	
SRG-6,0	6 mm	H - Class Makaron 1,5 KV	100	500	
SRG-7,0	7 mm	H - Class Makaron 1,5 KV	100	500	
SRG-8,0	8 mm	H - Class Makaron 1,5 KV	100	400	
SRG-10,0	10 mm	H - Class Makaron 1,5 KV	100	400	
SRG-12,0	12 mm	H - Class Makaron 1,5 KV	50	250	
SRG-14,0	14 mm	H - Class Makaron 1,5 KV	50	250	
SRG-16,0	16 mm	H - Class Makaron 1,5 KV	50	200	
SRG-18,0	18 mm	H - Class Makaron 1,5 KV	50	200	
SRG-20,0	20 mm	H - Class Makaron 1,5 KV	50	200	
SRG-25,0	25 mm	H - Class Makaron 1,5 KV	25	125	
SRG-30,0	30 mm	H - Class Makaron 1,5 KV	25	100	
SRG-35,0	35 mm	H - Class Makaron 1,5 KV	25	100	
SRG-40,0	40 mm	H - Class Makaron 1,5 KV	25	100	
SRG-50,0	50 mm	H - Class Makaron 1,5 KV	25	75	

KSN® H - CLASS SİLİKONLU MAKARONLAR

İTHALATIMIZ

ÜRÜN KODU	CİNSİ		RULO (m)	KOLİ MİKTARI (m)	FİYAT (\$) (m)
SRG-1,0	1 mm	H - Class Makaron 4 KV	100	1.500	
SRG-1,5	1,5 mm	H - Class Makaron 4 KV	100	1.500	
SRG-2,0	2 mm	H - Class Makaron 4 KV	100	1.000	
SRG-2,5	2,5 mm	H - Class Makaron 4 KV	100	1.000	
SRG-3,0	3 mm	H - Class Makaron 4 KV	100	600	
SRG-4,0	4 mm	H - Class Makaron 4 KV	100	500	
SRG-5,0	5 mm	H - Class Makaron 4 KV	100	500	
SRG-6,0	6 mm	H - Class Makaron 4 KV	100	500	
SRG-7,0	7 mm	H - Class Makaron 4 KV	100	500	
SRG-8,0	8 mm	H - Class Makaron 4 KV	100	400	
SRG-10,0	10 mm	H - Class Makaron 4 KV	100	400	
SRG-12,0	12 mm	H - Class Makaron 4 KV	50	250	
SRG-14,0	14 mm	H - Class Makaron 4 KV	50	250	
SRG-16,0	16 mm	H - Class Makaron 4 KV	50	200	
SRG-18,0	18 mm	H - Class Makaron 4 KV	50	200	
SRG-20,0	20 mm	H - Class Makaron 4 KV	50	200	
SRG-25,0	25 mm	H - Class Makaron 4 KV	25	125	
SRG-30,0	30 mm	H - Class Makaron 4 KV	25	100	
SRG-35,0	35 mm	H - Class Makaron 4 KV	25	100	
SRG-40,0	40 mm	H - Class Makaron 4 KV	25	100	
SRG-50,0	50 mm	H - Class Makaron 4 KV	25	75	

KSN® CAM ELYAF MAKARONLAR

2,5 kV

İTHALATIMIZ

ÜRÜN KODU	CİNSİ		RULO (m)	FİYAT (\$) (m)
KSNCAM-08	0,8 mm	Cam Elyaf Makaron 2,5 KV	200	0,064 \$
KSNCAM-1	1 mm	Cam Elyaf Makaron 2,5 KV	200	0,064 \$
KSNCAM-1,5	1,5 mm	Cam Elyaf Makaron 2,5 KV	100	0,084 \$
KSNCAM-2	2 mm	Cam Elyaf Makaron 2,5 KV	100	0,094 \$
KSNCAM-2,5	2,5 mm	Cam Elyaf Makaron 2,5 KV	100	0,113 \$
KSNCAM-3	3 mm	Cam Elyaf Makaron 2,5 KV	100	0,125 \$
KSNCAM-4	4 mm	Cam Elyaf Makaron 2,5 KV	100	0,170 \$
KSNCAM-5	5 mm	Cam Elyaf Makaron 2,5 KV	100	0,280 \$
KSNCAM-6	6 mm	Cam Elyaf Makaron 2,5 KV	100	0,300 \$
KSNCAM-7	7 mm	Cam Elyaf Makaron 2,5 KV	100	0,370 \$
KSNCAM-8	8 mm	Cam Elyaf Makaron 2,5 KV	100	0,400 \$
KSNCAM-10	10 mm	Cam Elyaf Makaron 2,5 KV	100	0,630 \$
KSNCAM-12	12 mm	Cam Elyaf Makaron 2,5 KV	50	0,760 \$
KSNCAM-14	14 mm	Cam Elyaf Makaron 2,5 KV	50	0,810 \$
KSNCAM-16	16 mm	Cam Elyaf Makaron 2,5 KV	50	1,100 \$
KSNCAM-18	18 mm	Cam Elyaf Makaron 2,5 KV	50	1,480 \$
KSNCAM-20	20 mm	Cam Elyaf Makaron 2,5 KV	25	1,700 \$
KSNCAM-25	25 mm	Cam Elyaf Makaron 2,5 KV	25	3,400 \$
KSNCAM-30	30 mm	Cam Elyaf Makaron 2,5 KV	25	3,850 \$
KSNCAM-35	35 mm	Cam Elyaf Makaron 2,5 KV	25	7,300 \$



2,5 kV



PVC CAM ELYAF MAKARON

TEKNİK ÖZELLİKLER
Malzeme:

PVC İzoleli Cam Elyaf Makaron

Çalışma Sıcaklığı:

-60 °C + 250 °C





KSN®
PVC CAM ELYAF MAKARON

2,5 kV
TEKNİK ÖZELLİKLER
Malzeme:

PVC İzoleli Cam Elyaf Makaron

Çalışma Sıcaklığı:

-60 °C + 250 °C



RENK	CİNSİ	RULO (m)	FİYAT (\$) (m)
KIRMIZI	1 mm Cam Elyaf Makaron 2,5 kV	200	0,064 \$
	1,5 mm Cam Elyaf Makaron 2,5 kV	200	0,084 \$
	2 mm Cam Elyaf Makaron 2,5 kV	200	0,094 \$
	2,5 mm Cam Elyaf Makaron 2,5 kV	200	0,113 \$
	3 mm Cam Elyaf Makaron 2,5 kV	100	0,125 \$
	4 mm Cam Elyaf Makaron 2,5 kV	100	0,170 \$
	5 mm Cam Elyaf Makaron 2,5 kV	100	0,280 \$
	6 mm Cam Elyaf Makaron 2,5 kV	100	0,300 \$
MAVİ	1 mm Cam Elyaf Makaron 2,5 kV	200	0,064 \$
	1,5 mm Cam Elyaf Makaron 2,5 kV	200	0,084 \$
	2 mm Cam Elyaf Makaron 2,5 kV	200	0,094 \$
	2,5 mm Cam Elyaf Makaron 2,5 kV	200	0,113 \$
	3 mm Cam Elyaf Makaron 2,5 kV	100	0,125 \$
	4 mm Cam Elyaf Makaron 2,5 kV	100	0,170 \$
	5 mm Cam Elyaf Makaron 2,5 kV	100	0,280 \$
	6 mm Cam Elyaf Makaron 2,5 kV	100	0,300 \$
SARI	1 mm Cam Elyaf Makaron 2,5 kV	200	0,064 \$
	1,5 mm Cam Elyaf Makaron 2,5 kV	200	0,084 \$
	2 mm Cam Elyaf Makaron 2,5 kV	200	0,094 \$
	2,5 mm Cam Elyaf Makaron 2,5 kV	200	0,113 \$
	3 mm Cam Elyaf Makaron 2,5 kV	100	0,125 \$
	4 mm Cam Elyaf Makaron 2,5 kV	100	0,170 \$
	5 mm Cam Elyaf Makaron 2,5 kV	100	0,280 \$
	6 mm Cam Elyaf Makaron 2,5 kV	100	0,300 \$
YEŞİL	1 mm Cam Elyaf Makaron 2,5 kV	200	0,064 \$
	1,5 mm Cam Elyaf Makaron 2,5 kV	200	0,084 \$
	2 mm Cam Elyaf Makaron 2,5 kV	200	0,094 \$
	2,5 mm Cam Elyaf Makaron 2,5 kV	200	0,113 \$
	3 mm Cam Elyaf Makaron 2,5 kV	100	0,125 \$
	4 mm Cam Elyaf Makaron 2,5 kV	100	0,170 \$
	5 mm Cam Elyaf Makaron 2,5 kV	100	0,280 \$
	6 mm Cam Elyaf Makaron 2,5 kV	100	0,300 \$
SİYAH	1 mm Cam Elyaf Makaron 2,5 kV	200	0,064 \$
	1,5 mm Cam Elyaf Makaron 2,5 kV	200	0,084 \$
	2 mm Cam Elyaf Makaron 2,5 kV	200	0,094 \$
	2,5 mm Cam Elyaf Makaron 2,5 kV	200	0,113 \$
	3 mm Cam Elyaf Makaron 2,5 kV	100	0,125 \$
	4 mm Cam Elyaf Makaron 2,5 kV	100	0,170 \$
	5 mm Cam Elyaf Makaron 2,5 kV	100	0,280 \$
	6 mm Cam Elyaf Makaron 2,5 kV	100	0,300 \$



www.konsangroup.com

KABLO BAĞLARI VE AKSESUARLAR

KSN[®]
KABLO BAĞLARI

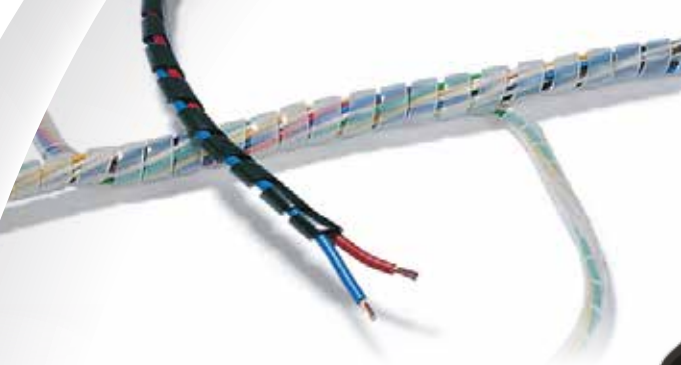



TEKNİK ÖZELLİKLER
Malzeme:

Naylon 6.6 Standart UL

Çalışma Sıcaklığı:

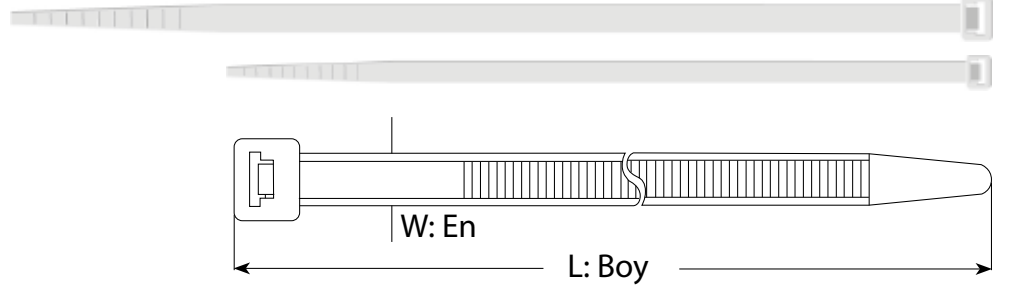
-40 °C + 85 °C



ÜRÜN KODU	Boyutlar		Renk	Azami Sıkma Çapı (mm)	Açılma Mukavemeti (Kg)	Poşet Miktarı	Koli Adedi	Birim Fiyat Adet (₺)
	Uzunluk (mm)	En (mm)						
KCT - 100 M	100	2,5	Beyaz	20	8 KG	1.000	50.000	0,320 ₺
KCT - 100 M	100		Beyaz	20		100	50.000	0,400 ₺
KCT - 150 M	150		Beyaz	36		100	50.000	0,500 ₺
KCT - 200 M	200		Beyaz	52		100	25.000	0,680 ₺
KCT - 150 I	150	3,6	Beyaz	36	18 KG	100	20.000	0,790 ₺
KCT - 200 I	200		Beyaz	52		100	20.000	1,040 ₺
KCT - 250 I	250		Beyaz	68		100	20.000	1,270 ₺
KCT - 300 I	300		Beyaz	78		100	15.000	1,560 ₺
KCT - 370 I	370		Beyaz	106		100	10.000	1,950 ₺
KCT - 200 ST	200	4,8	Beyaz	50	25 KG	100	10.000	1,470 ₺
KCT - 250 ST	250		Beyaz	65		100	10.000	1,800 ₺
KCT - 300 ST	300		Beyaz	81		100	10.000	2,250 ₺
KCT - 370 ST	370		Beyaz	103		100	10.000	2,520 ₺
KCT - 400 ST	400		Beyaz	113		100	5.000	3,000 ₺
KCT - 430 ST	430		Beyaz	122		100	5.000	3,400 ₺
KCT - 550 ST	550		Beyaz	160		100	5.000	4,950 ₺
KCT - 300 HD	300	7,6	Beyaz	82	55 KG	100	5.000	4,650 ₺
KCT - 370 HD	370		Beyaz	108		100	5.000	4,950 ₺
KCT - 450 HD	450		Beyaz	130		100	2.500	5,500 ₺
KCT - 550 HD	550		Beyaz	159		100	2.500	7,700 ₺
KCT - 610 HD	610		Beyaz	181		100	2.000	9,200 ₺
KCT - 750 HD	750		Beyaz	226		100	2.000	12,150 ₺
KCT - 610 HD	610	9	Beyaz	182	80 KG	100	2.000	14,000 ₺
KCT - 710 HD	710		Beyaz	195		100	2.000	14,500 ₺
KCT - 760 HD	760		Beyaz	229		100	2.000	16,000 ₺
KCT - 920 HD	920		Beyaz	280		100	1.000	18,500 ₺
KCT - 1020 HD	1020		Beyaz	295		100	1.000	21,400 ₺
KCT - 1220 HD	1220		Beyaz	375		100	1.000	26,000 ₺

KSN® SİYAH KABLO BAĞLARI

İTHALATIMIZ



TEKNİK ÖZELLİKLER

Malzeme:

Naylon 6.6 Standart UL

Çalışma Sıcaklığı:

-40 °C + 85 °C

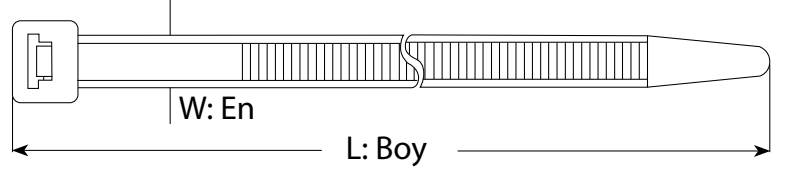

ÜRÜN KODU	Boyutlar		Renk	Azami Sıkma Çapı (mm)	Açılma Mukavemeti (Kg)	Poşet Miktarı	Koli Adedi	Birim Fiyat Adet (₺)
	Uzunluk (mm)	En (mm)						
KCT - 100 MB	100	2,5	Siyah	20	8 KG	1.000	50.000	0,320 ₺
KCT - 100 MB	100		Siyah	20		100	50.000	0,400 ₺
KCT - 150 MB	150		Siyah	36		100	50.000	0,500 ₺
KCT - 200 MB	200		Siyah	52		100	25.000	0,680 ₺
KCT - 150 IB	150	3,6	Siyah	36	18 KG	100	20.000	0,790 ₺
KCT - 200 IB	200		Siyah	52		100	20.000	1,040 ₺
KCT - 250 IB	250		Siyah	68		100	20.000	1,270 ₺
KCT - 300 IB	300		Siyah	78		100	15.000	1,560 ₺
KCT - 370 IB	370		Siyah	106		100	10.000	1,950 ₺
KCT - 200 STB	200	4,8	Siyah	50	25 KG	100	10.000	1,470 ₺
KCT - 250 STB	250		Siyah	65		100	10.000	1,800 ₺
KCT - 300 STB	300		Siyah	81		100	10.000	2,250 ₺
KCT - 370 STB	370		Siyah	103		100	10.000	2,520 ₺
KCT - 400 STB	400		Siyah	113		100	5.000	3,000 ₺
KCT - 430 STB	430		Siyah	122		100	5.000	3,400 ₺
KCT - 550 STB	550		Siyah	160		100	5.000	4,950 ₺
KCT - 300 HDB	300	7,6	Siyah	82	55 KG	100	5.000	4,650 ₺
KCT - 370 HDB	370		Siyah	108		100	5.000	4,950 ₺
KCT - 450 HDB	450		Siyah	130		100	2.500	5,500 ₺
KCT - 550 HDB	550		Siyah	159		100	2.500	7,700 ₺
KCT - 610 HDB	610		Siyah	181		100	2.000	9,200 ₺
KCT - 750 HDB	750		Siyah	226		100	2.000	12,150 ₺
KCT - 610 HDB	610	9	Siyah	182	80 KG	100	2.000	14,000 ₺
KCT - 710 HDB	710		Siyah	195		100	2.000	14,500 ₺
KCT - 760 HDB	760		Siyah	229		100	2.000	16,000 ₺
KCT - 920 HDB	920		Siyah	280		100	1.000	18,500 ₺
KCT - 1020 HDB	1020		Siyah	295		100	1.000	21,400 ₺
KCT - 1220 HDB	1220		Siyah	375		100	1.000	26,000 ₺

KSN® RENKLİ KABLO BAĞLARI

İTHALATIMIZ

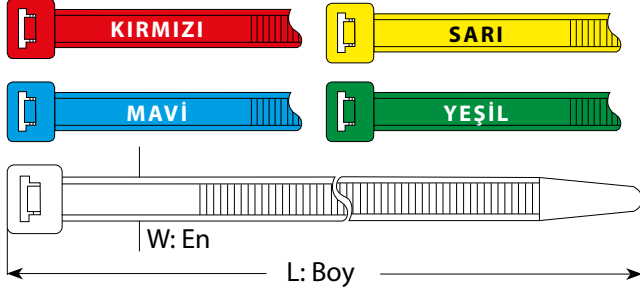
TEKNİK ÖZELLİKLER
Malzeme:

Naylon 6.6 Standart UL

Çalışma Sıcaklığı:

-40 °C + 85 °C

ÜRÜN KODU	Boyutlar		Renk	Azami Sıkma Çapı (mm)	Açılma Mukavemeti (Kg)	Poşet Miktarı	Koli Adedi	Birim Fiyat Adet (₺)
	Uzunluk (mm)	En (mm)						
KCT - 100 M	100	2,5	● Kırmızı	20	8 KG	1.000	50.000	0,360 ₺
KCT - 150 I	150	3,6	● Kırmızı	36	18 KG	100	20.000	0,870 ₺
KCT - 200 I	200		● Kırmızı	52		100	20.000	1,150 ₺
KCT - 250 I	250		● Kırmızı	68		100	20.000	1,400 ₺
KCT - 300 I	300		● Kırmızı	78		100	15.000	1,750 ₺
KCT - 200 ST	200		● Kırmızı	50		25 KG	100	10.000
KCT - 250 ST	250	● Kırmızı	65	100	10.000		2,000 ₺	
KCT - 300 ST	300	● Kırmızı	81	100	10.000		2,500 ₺	
KCT - 370 ST	370	● Kırmızı	103	100	10.000		2,900 ₺	
KCT - 430 ST	430	● Kırmızı	122	100	5.000		5,200 ₺	
KCT - 370 HD	370	7,6	● Kırmızı	108	55 KG	100	5.000	7,950 ₺
KCT - 100 M	100	2,5	● Sarı	20	8 KG	1.000	50.000	0,360 ₺
KCT - 150 I	150	3,6	● Sarı	36	18 KG	100	20.000	0,870 ₺
KCT - 200 I	200		● Sarı	52		100	20.000	1,150 ₺
KCT - 250 I	250		● Sarı	68		100	20.000	1,400 ₺
KCT - 300 I	300		● Sarı	78		100	15.000	1,750 ₺
KCT - 200 ST	200		● Sarı	50		25 KG	100	10.000
KCT - 250 ST	250	● Sarı	65	100	10.000		2,000 ₺	
KCT - 300 ST	300	● Sarı	81	100	10.000		2,500 ₺	
KCT - 370 ST	370	● Sarı	103	100	10.000		2,900 ₺	
KCT - 430 ST	430	● Sarı	122	100	5.000		5,200 ₺	
KCT - 370 HD	370	7,6	● Sarı	108	55 KG	100	5.000	7,950 ₺
KCT - 100 M	100	2,5	● Mavi	20	8 KG	1.000	50.000	0,360 ₺
KCT - 150 I	150	3,6	● Mavi	36	18 KG	100	20.000	0,870 ₺
KCT - 200 I	200		● Mavi	52		100	20.000	1,150 ₺
KCT - 250 I	250		● Mavi	68		100	20.000	1,400 ₺
KCT - 300 I	300		● Mavi	78		100	15.000	1,750 ₺
KCT - 200 ST	200		● Mavi	50		25 KG	100	10.000
KCT - 250 ST	250	● Mavi	65	100	10.000		2,000 ₺	
KCT - 300 ST	300	● Mavi	81	100	10.000		2,500 ₺	
KCT - 370 ST	370	● Mavi	103	100	10.000		2,900 ₺	
KCT - 430 ST	430	● Mavi	122	100	5.000		5,200 ₺	
KCT - 370 HD	370	7,6	● Mavi	108	55 KG	100	5.000	7,950 ₺
KCT - 100 M	100	2,5	● Yeşil	20	8 KG	1.000	50.000	0,360 ₺
KCT - 150 I	150	3,6	● Yeşil	36	18 KG	100	20.000	0,870 ₺
KCT - 200 I	200		● Yeşil	52		100	20.000	1,150 ₺
KCT - 250 I	250		● Yeşil	68		100	20.000	1,400 ₺
KCT - 300 I	300		● Yeşil	78		100	15.000	1,750 ₺
KCT - 200 ST	200		● Yeşil	50		25 KG	100	10.000
KCT - 250 ST	250	● Yeşil	65	100	10.000		2,000 ₺	
KCT - 300 ST	300	● Yeşil	81	100	10.000		2,500 ₺	
KCT - 370 ST	370	● Yeşil	103	100	10.000		2,900 ₺	
KCT - 430 ST	430	● Yeşil	122	100	5.000		5,200 ₺	
KCT - 370 HD	370	7,6	● Yeşil	108	55 KG	100	5.000	7,950 ₺

KSN® ETİKETLİ BEYAZ KABLO BAĞLARI

İTHALATIMIZ

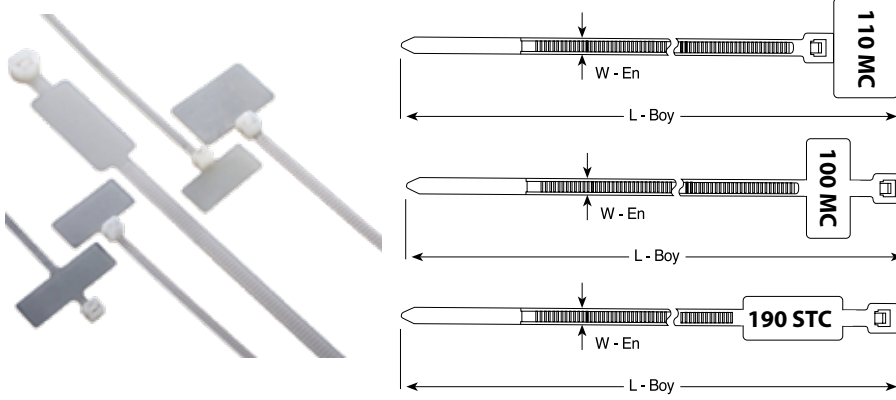

TEKNİK ÖZELLİKLER

Malzeme: Naylon 6.6 Standart UL
Çalışma Sıcaklığı: -40 °C + 85 °C

ÜRÜN KODU	Boy (mm)	En (mm)	Maksimum Bağlama Çapı	Açılma Mukavemeti (Kg)	Poşet Adedi	Koli Adedi	Birim Fiyat (₺)
KCT-100 MC	100	2,5	22	8	100	20.000	1,150 ₺
KCT-110 MC	110	2,5	22	8	100	20.000	1,700 ₺
KCT-190 STC	190	4,8	50	22	100	10.000	2,700 ₺

KSN® PANELE KAFADAN SIKIŞAN BEYAZ KABLO BAĞLARI

İTHALATIMIZ

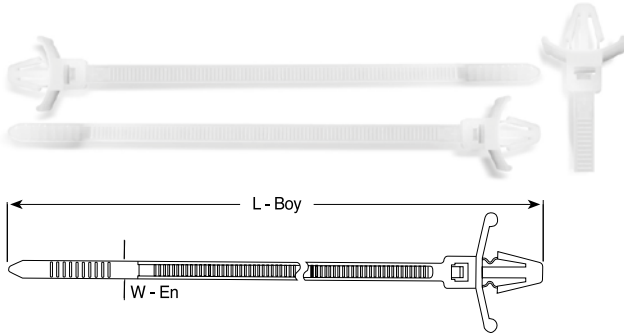

TEKNİK ÖZELLİKLER

Malzeme: Naylon 6.6 Standart UL
Çalışma Sıcaklığı: -40 °C + 85 °C

ÜRÜN KODU	Boy (mm)	En (mm)	Maksimum Bağlama Çapı	Açılma Mukavemeti (Kg)	Poşet Adedi	Koli Adedi	Birim Fiyat (₺)
KCT-PT 100 M	100	2,5	20	8	100	25.000	1,100 ₺
KCT-PT 150 I	150	3,6	35	18	100	20.000	1,550 ₺
KCT-PT 200 ST	200	4,8	50	23	100	10.000	3,200 ₺

KSN® AÇILABİLİR BEYAZ KABLO BAĞLARI

İTHALATIMIZ

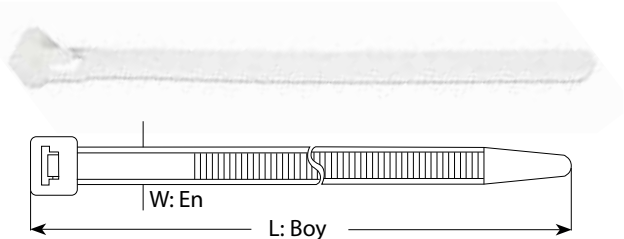

TEKNİK ÖZELLİKLER

Malzeme: Naylon 6.6 Standart UL
Çalışma Sıcaklığı: -40 °C + 85 °C

ÜRÜN KODU	Boy (mm)	En (mm)	Maksimum Bağlama Çapı	Açılma Mukavemeti (Kg)	Poşet Adedi	Koli Adedi	Birim Fiyat (₺)
KCT-SHA 250 HD	250	7,6	60	22	100	5.000	3,700 ₺
KCT-SHA 370 HD	370	7,6	100	22	100	3.000	6,000 ₺

KSN® 304 PASLANMAZ ÇELİK KABLO BAĞLARI

İTHALATIMIZ

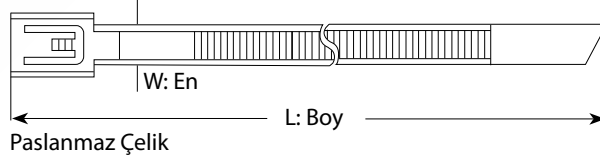

TEKNİK ÖZELLİKLER

Malzeme: 304 Paslanmaz Çelik
Su Emilimi: Yok
Alev Yürümeme: UL94V-2
UV Dayanıklılığı: Mükemmel
Kimyasal Dayanıklılık: Mükemmel
Çalışma Sıcaklığı: -80 °C + 538 °C

ÜRÜN KODU	L	W	Maksimum Bağlama Çapı	Açılma Mukavemeti (Kg)	Poşet Adedi	Koli Adedi	Birim Fiyat
K-MTL-150 ST	150	4.6	46	65	100	5.000	5,300 ₺
K-MTL-200 ST	200		61	65		5.000	5,600 ₺
K-MTL-260 ST	260		81	65		5.000	6,600 ₺
K-MTL-300 ST	300		90	65		5.000	7,200 ₺
K-MTL-370 ST	370		112	65		4.000	8,200 ₺
K-MTL-450 ST	450		130	65		4.000	10,000 ₺
K-MTL-520 ST	520		163	65		3.000	10,500 ₺
K-MTL-680 ST	680		214	65		2.000	12,900 ₺
K-MTL-840 ST	840		265	65		1.000	15,200 ₺
K-MTL-200 HD	200	7.9	61	130	100	5.000	9,600 ₺
K-MTL-300 HD	300		90	130		4.000	11,800 ₺
K-MTL-370 HD	370		112	130		3.000	13,700 ₺
K-MTL-450 HD	450		130	130		4.000	15,500 ₺
K-MTL-520 HD	520		163	130		2.000	17,500 ₺
K-MTL-680 HD	680		214	130		2.000	20,800 ₺
K-MTL-840 HD	840		265	130		1.000	24,300 ₺

KSN® 304 PASLANMAZ ÇELİK ETİKET

İTHALATIMIZ

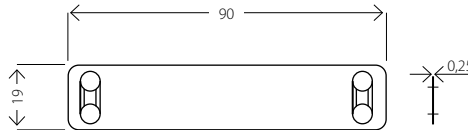

TEKNİK ÖZELLİKLER

Malzeme: 304 Paslanmaz Çelik
Su Emilimi: Yok
Alev Yürümeme: UL94V-2
UV Dayanıklılığı: Mükemmel
Kimyasal Dayanıklılık: Mükemmel
Çalışma Sıcaklığı: -80 °C + 538 °C

ÜRÜN KODU	ÜRÜN AÇIKLAMASI	Renk	Boy ve Genişlik (mm)	Ambalaj (Adet)	Koli Miktarı (Adet)	Birim Fiyat
K-MTL-ETK	Paslanmaz Çelik Etiket	Metal	19 x 90 mm	100	5.000	12,350 ₺

Paslanmaz Çelik Kablo Bağları

- Kendiliğinden kilitlenebilir kafa tasarımı, kurulumu hızlandırır ve kablo bağı gövdesi boyunca herhangi bir boyda kilitlemeyi sağlar.
- Güçlü ve dayanıklı kablo bağlama yöntemini temin eder.
- Çok çeşitli iç mekân ve dış mekân uygulama alanlarında kullanılabilir.
- Pürüzsüz yüzeyi ve yuvarlatılmış uçları ile kablonun korunmasını ve çalışan kişinin güvenliğini garanti eder.
- Şebeke kablolarında en üst düzey desteği sağlar.
- Genel amaçlı uygulamalar için : 304 paslanmaz çelik

KSN® 304 PASLANMAZ ÇELİK POLYESTER KAPLI KABLO BAĞLARI

İTHALATIMIZ

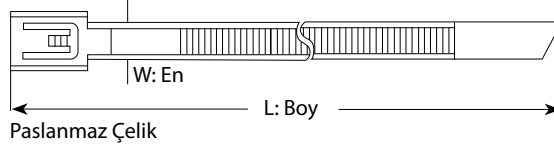

TEKNİK ÖZELLİKLER

Malzeme: 304 Paslanmaz Çelik
Su Emilimi: Yok
Alev Yürümeme: UL94V-2
UV Dayanıklılığı: Mükemmel
Kimyasal Dayanıklılık: Mükemmel
Çalışma Sıcaklığı: -40 °C + 150 °C

ÜRÜN KODU	L	W	Maksimum Bağlama Çapı	Açılma Mukavemeti (Kg)	Poşet Adedi	Koli Adedi	Birim Fiyat
K-PMTL-150 ST	150	4.6	46	65	100	5.000	7,000 ₺
K-PMTL-200 ST	200		61	65		5.000	7,800 ₺
K-PMTL-260 ST	260		81	65		5.000	8,700 ₺
K-PMTL-300 ST	300		90	65		5.000	9,600 ₺
K-PMTL-370 ST	370		112	65		4.000	11,500 ₺
K-PMTL-520 ST	520		163	65		3.000	15,000 ₺
K-PMTL-680 ST	680		214	65		2.000	18,500 ₺
K-PMTL-840 ST	840		265	65		1.000	23,500 ₺
K-PMTL-200 HD	200	7.9	61	130	100	5.000	12,000 ₺
K-PMTL-300 HD	300		90	130		4.000	15,200 ₺
K-PMTL-370 HD	370		112	130		3.000	17,700 ₺
K-PMTL-520 HD	520		163	130		2.000	23,200 ₺
K-PMTL-680 HD	680		214	130		2.000	28,400 ₺
K-PMTL-840 HD	840		265	130		1.000	33,500 ₺

Paslanmaz Çelik Kablo Bağları

- Kendiliğinden kilitlenebilir kafa tasarımı, kurulumu hızlandırır ve kablo bağı gövdesi boyunca herhangi bir boyda kilitlemeyi sağlar.
- Güçlü ve dayanıklı kablo bağlama yöntemini temin eder.
- Çok çeşitli iç mekân ve dış mekân uygulama alanlarında kullanılabilir.
- Pürüzsüz yüzeyi ve yuvarlatılmış uçları ile kablunun korunmasını ve çalışan kişinin güvenliğini garanti eder.
- Şebeke kablolarında en üst düzey desteği sağlar.
- Genel amaçlı uygulamalar için : 304 paslanmaz çelik
- Polyester kaplıdır.

KSN® TIRNAKLI KABLO BAĞI

İTHALATIMIZ



ÜRÜN KODU	L (mm)	W (mm)	Poşet Adedi	Koli Adedi	ADET (₺)
KCT-200 ECT	200	4,8	100	5.000	11,250 ₺

Tırnaklı Kablo Bağı Aparatı

- Kablo bağlama kafası paketlemeden sonra hareket ettirilebilir.
- Otomotiv endüstrisinde kablo, boru ve hortumların sabitlenmesi ve demonte edilmesi, kablo demeti yapımı, panel yapımı ve elektrik endüstrisinde yaygın olarak kullanılmaktadır.

Malzeme

- Poliamid 6.6 UV ile stabilize edilmiş (PA66UV)
- Kablo Bağlantıları: Polyamide 6.6, ısıya dayanıklı (PA66HS)
- Ayak bölümü: Polyamid 6.6, yüksek darbe tadil edilmiş, ısıya dayanıklı (PA66HIRHS)

Operasyon Sıcaklığı

- Polyamid 6.6 UV ile stabilize edilmiş (PA66UV): -40 °C ila + 85 °C
- Isıya dayanıklı (PA66HS): -40 °C ila + 115 °C



KSN® YAPIŞKANLI KROŞELER

İTHALATIMIZ

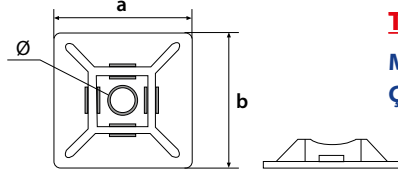

TEKNİK ÖZELLİKLER

Malzeme: Naylon 6.6 Standart UL
Çalışma Sıcaklığı: -40 °C + 85 °C

ÜRÜN KODU	a (mm)	b (mm)	Delik Çapı (mm)	Maksimum Kablo Bağı Eni (mm)	Renk	Poşet Adedi	Koli Adedi	Birim Fiyat (₺)
KCT-HW 3A	19	19	Ø 3,2	3,6	Beyaz	100	5.000	1,750 ₺
KCT-HW 4A	28	28	Ø 3,2	4,8	Beyaz	100	5.000	3,200 ₺
KCT-HW 3AB	19	19	Ø 4,3	3,6	Siyah	100	5.000	1,750 ₺
KCT-HW 4AB	28	28	Ø 4,3	4,8	Siyah	100	5.000	3,200 ₺

KSN® VİDALI KROŞE

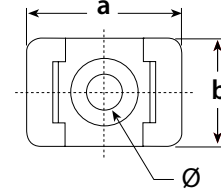
İTHALATIMIZ



TEKNİK ÖZELLİKLER

Malzeme: Naylon 6.6 Standart UL
Çalışma Sıcaklığı: -40 °C + 85 °C

ÜRÜN KODU	a (mm)	b (mm)	Delik Çapı (mm)	Maksimum Kablo Bağı Eni (mm)	Renk	Poşet Adedi	Koli Adedi	Birim Fiyat (₺)
KCT-VK 1	15	10	Ø 5	3,6	Beyaz	100	5.000	1,300 ₺
KCT-VK 2	23	16	Ø 10	7,6	Beyaz	100	5.000	1,950 ₺
KCT-VK 1B	15	10	Ø 5	3,6	Siyah	100	5.000	1,300 ₺
KCT-VK 2B	23	16	Ø 10	7,6	Siyah	100	5.000	1,950 ₺

KSN® YAPIŞKANLI KABLO TUTUCU

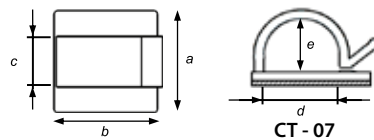
İTHALATIMIZ



TEKNİK ÖZELLİKLER

Malzeme: Naylon 6.6 Standart UL
Çalışma Sıcaklığı: -40 °C + 85 °C

ÜRÜN KODU	A	B	C	D	MAX. BAĞLAMA GENİŞLİĞİ (E)	KOLİ ADEDİ	AD. / ₺
KCT-KT 12	25	25	12,7	12,5	8	5.000	6,370 ₺
KCT-KT 15	25	25	12,7	16,5	12	5.000	8,000 ₺

KSN® KABLO KLİPSİ

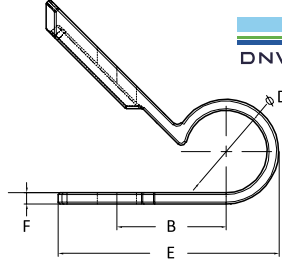
İTHALATIMIZ



TEKNİK ÖZELLİKLER

Malzeme: Naylon 6.6 Standart UL
Çalışma Sıcaklığı: -40 °C + 185 °C

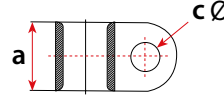

ÜRÜN KODU	a (mm)	E (mm)	c (mm)	D (mm)	F (mm)	Poşet Adedi	Koli Adedi	Birim Fiyat (₺)
KPKL-03	9,6	16,9	4	3,0 (1/8")	1,2	100	20.000	0,960 ₺
KPKL-05	9,6	18,5	4	5,3 (3/16")	1,2	100	20.000	0,980 ₺
KPKL-06	10,1	20	4	6,8 (1/4")	1,2	100	15.000	1,150 ₺
KPKL-08	10	22,6	4	8,4 (5/16")	1,2	100	10.000	1,450 ₺
KPKL-10	12,3	26,6	5	10,8 (3/8")	1,4	100	6.000	1,700 ₺
KPKL-13	12,2	30,3	5	13,8 (1/2")	1,4	100	9.000	2,340 ₺
KPKL-16	12,4	32,6	5	17,4 (5/8")	1,4	100	8.000	3,250 ₺
KPKL-19	11,8	37,3	5	19,9 (3/4")	1,4	100	6.000	3,500 ₺
KPKL-25	12	43,4	5	27,2 (1")	1,4	100	4.500	4,160 ₺
KPKL-32	12	52,3	5	33,8 (1 1/4")	1,6	100	3.000	5,350 ₺
KPKL-38	12,5	58,3	5	41,9 (1 1/2")	1,5	100	2.500	6,240 ₺

KSN® DÜBEL KROŞE

İTHALATIMIZ

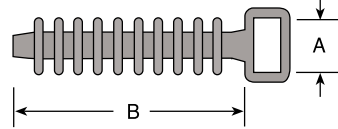

TEKNİK ÖZELLİKLER

Malzeme: Naylon 6.6 Standart UL
Çalışma Sıcaklığı: -40 °C + 85 °C

ÜRÜN KODU	a (mm)	b (mm)	Delik Çapı (mm)	Maksimum Kablo Bağı Eni (mm)	Poşet Adedi	Koli Adedi	Birim Fiyat (₺)
KCT-TH 2	10,6	43,6	Ø 10,3	9	100	5.000	2,250 ₺

KSN® BASKILI DEVRE TAŞIYICILARI

İTHALATIMIZ



TEKNİK ÖZELLİKLER

Malzeme: Naylon 6.6 Standart UL
Çalışma Sıcaklığı: -40 °C + 85 °C

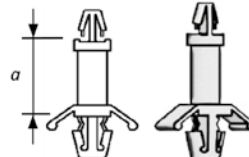

KSN-70-1070

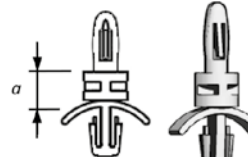

KSN-08-1008

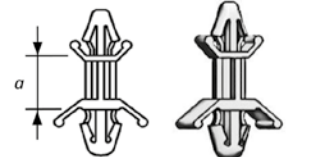

KSN-71-1071



KSN-72-1072

ÜRÜN KODU	Yükseklik (mm)	Genişlik (mm)	Üst Delik Çapı (mm)	Alt Delik Çapı (mm)	a (mm)	Poşet Adedi	Koli Adedi	Birim Fiyat (₺)
KSN-08-1008	24,5	15	Ø 4	Ø 4,5	6,2	500	40.000	4,000 ₺
KSN-70-1070	27	14,4	Ø 3	Ø 4,8	13,9	250	35.000	2,000 ₺
KSN-71-1071	26,5	15,3	Ø 4	Ø 4,8	9,2	250	40.000	2,000 ₺
KSN-72-1072	30	15,3	Ø 4	Ø 4,8	12,6	250	35.000	2,100 ₺

KSN® YAPIŞKANLI BÜKÜLEBİLİR KLİPS

İTHALATIMIZ

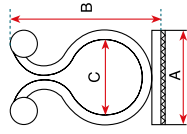

TEKNİK ÖZELLİKLER

Malzeme: Naylon 6.6 Standart UL
Çalışma Sıcaklığı: -40 °C + 85 °C



ÜRÜN KODU	A	B	C	POŞET ADEDİ	AD. / ʘ
KSN-8435	20 x 20	32	16	100	34,000 ʘ

KSN® KABLO BAĞI ETİKET TAŞIYICI

İTHALATIMIZ



TEKNİK ÖZELLİKLER

Malzeme: Naylon 6.6 Standart UL
Çalışma Sıcaklığı: -40 °C + 85 °C



ÜRÜN KODU	Boy (mm)	Genişlik (mm)	Poşet Adedi	Koli Adedi	Birim Fiyat (ʘ)
KCT-ET 07 907	10	35	100	12.500	3,350 ʘ
KCT-ET 06 906	20	45	100	6.000	6,700 ʘ

KSN® YAPIŞKAN PANO ETİKETİ

İTHALATIMIZ

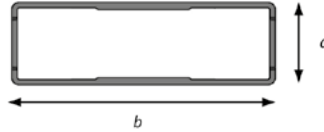

TEKNİK ÖZELLİKLER

Malzeme: Naylon 6.6 Standart UL
Çalışma Sıcaklığı: -40 °C + 85 °C



ÜRÜN KODU	a (mm)	b (mm)	Etiket Boyu (mm)	Etiket Eni (mm)	Poşet Adedi	Koli Adedi	Birim Fiyat (ʘ)
KSN-08-908	17	30	14,4	27,5	100	12.000	4,300 ʘ
KSN-03-903	17	50	15	49	50	6.000	6,000 ʘ
KSN-04-904	17	75	15	72	25	5.000	7,800 ʘ

KSN® KAPAMA PARÇASI

İTHALATIMIZ



TEKNİK ÖZELLİKLER

Malzeme: Bakır, Kalay kaplı
İzolasyon: Naylon 6.6 Standart, UL 94 / V2 normu
Çalışma Sıcaklığı: Maksimum 105 °C 300 Volt
Diğer Özellikler: (CE - 8) Modeli 600 Volt enerjiye dayanabilme özelliğine sahiptir.

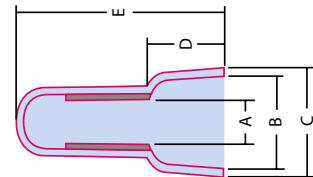

ÜRÜN KODU	Ölçüler (mm)					Kutu Adedi	ADET / ʘ
	A	B	C	D	E		
CE-1	2.6	6.2	7.8	6.0	18.0	1000	0,430 ʘ
CE-2	3.1	7.9	9.5	7.0	20.0	1000	0,450 ʘ
CE-3	4.0	8.8	10.3	7.5	21.5	1000	1,000 ʘ
CE-5	4.4	10.5	12.5	9.6	25.5	1000	1,200 ʘ
CE-8	5.3	12.4	14.3	12.0	27.7	500	3,300 ʘ

KSN® HELEZON KABLO SİRALLERİ

İTHALATIMIZ

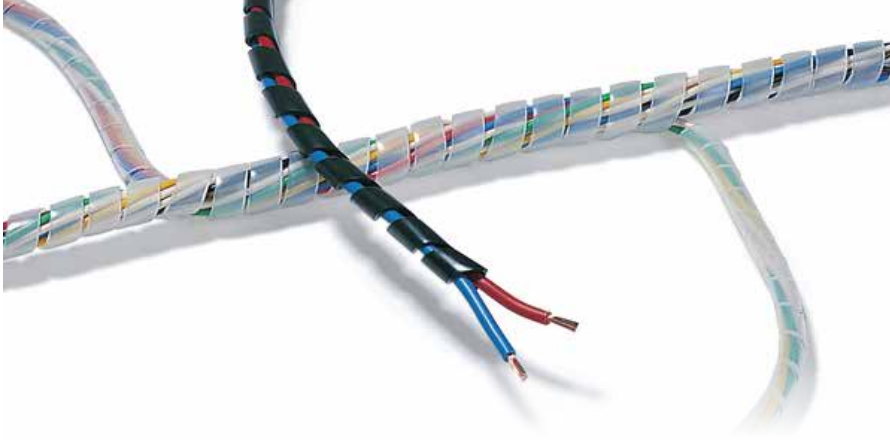

ÜRÜN KODU	Ölçüler (mm)				Renk	Paket Miktarı (m)	Koli Miktarı (m)	Metre Fiyatı (₺)
	T	D	W	Kablo Kesit (mm ²)				
KSPR-06 (No1)	0,60	6	7,5	2,5 - 15	Beyaz	10	1000	9,000 ₺
KSPR-08 (No2)	0,75	8	12	6 - 30	Beyaz	10	800	14,000 ₺
KSPR-10 (No3)	0,80	10	12,5	7,5 - 30	Beyaz	10	500	21,600 ₺
KSPR-12 (No4)	0,85	12	15	9 - 32	Beyaz	10	400	30,100 ₺
KSPR-15 (No5)	1,00	15	15,5	12 - 35	Beyaz	10	250	44,200 ₺
KSPR-19 (No6)	1,00	19	18	22 - 50	Beyaz	10	100	68,000 ₺
KSPR-06 B (No1)	0,60	6	7,5	2,5 - 15	Siyah	10	1000	9,000 ₺
KSPR-08 B (No2)	0,75	8	12	6 - 30	Siyah	10	800	14,000 ₺
KSPR-10 B (No3)	0,80	10	12,5	7,5 - 30	Siyah	10	500	21,600 ₺
KSPR-12 B (No4)	0,85	12	15	9 - 32	Siyah	10	400	30,100 ₺
KSPR-15 B (No5)	1,00	15	15,5	12 - 35	Siyah	10	250	44,200 ₺
KSPR-19 B (No6)	1,00	19	18	22 - 50	Siyah	10	100	68,000 ₺

TEKNİK ÖZELLİKLER

Malzeme: PE

Çalışma Sıcaklığı: -20 °C + 65 °C

Özellikler: Esnek yapısı sayesinde kabloları düzenlenmesine yardımcı olur. Güçlü yapısı sayesinde tekrar kullanıma uygundur.

KSN® EC TİPİ KABLO İŞARETLEME

İTHALATIMIZ

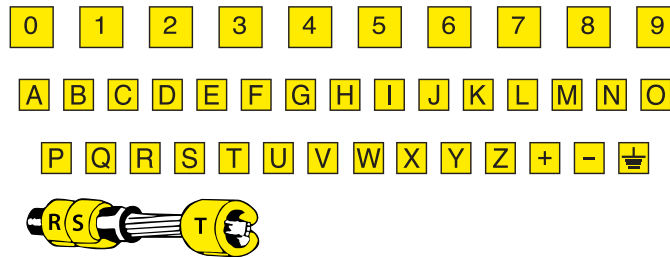

Kabloya yandan geçmeli,
montajdan önce takılabilen

ÜRÜN KODU	AÇIKLAMA	KABLO KESİTİ	MAKARA MİKTARI	BİRİM FİYATI (₺)
EC 0	Kablo İşaretleme	0,50 x 1,5 mm ²	1.000	135,000 ₺
EC 1	Kablo İşaretleme	1,50 x 6,0 mm ²	1.000	135,000 ₺
EC 2	Kablo İşaretleme	4,0 x 16,00 mm ²	500	135,000 ₺

KABLO YÜKSÜKLERİ VE PAPUÇLARI



www.konsangroup.com

KSN[®]
KABLO UÇLARI



KSN® İZOLELİ TEK GİRİŞ YÜKSÜKLER

FRANSIZ NORMU

İTHALATIMIZ

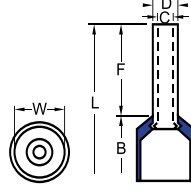

TEKNİK ÖZELLİKLER















Standart: DIN46228

Malzeme: Bakır, kalay kaplı

İzolasyon: Naylon

Çalışma Sıcaklığı: Maksimum 105 °C, 600 Volt arası



ÜRÜN KODU	TANIM	KESİT	BOYUTLAR		FRANSIZ RENK		KUTU ADEDİ	BİRİM FİYATI ₺
			F	L				
KSN-İY-0001	K-3002	0,25mm ²	8	12		Mor	1.000	1,150 ₺
KSN-İY-0002	K-3003	0,34 mm ²	8	12		Pembe	1.000	1,150 ₺
KSN-İY-0003	K-3005	0,50 mm ²	8	12		Beyaz	1.000	0,530 ₺
KSN-İY-0004	K-3007	0,75 mm ²	8	14		Mavi	1.000	0,530 ₺
KSN-İY-0005	K-3010	1,00 mm ²	8	14		Kırmızı	1.000	0,530 ₺
KSN-İY-0006	K-3015	1,50 mm ²	8	14		Siyah	1.000	0,590 ₺
KSN-İY-0007	K-3025	2,50 mm ²	8	14		Gri	500	0,750 ₺
KSN-İY-0008	K-3040	4,00 mm ²	10	17		Turuncu	500	1,270 ₺
KSN-İY-0009	K-3060	6,00 mm ²	12	20		Yeşil	250	1,760 ₺
KSN-İY-0010	K-3100	10,00 mm ²	12	22		Kahve	100	2,200 ₺
KSN-İY-0011	K-3160	16,00 mm ²	12	24		Bej	100	3,100 ₺
KSN-İY-0012	K-3250	25,00 mm ²	16	28		Siyah	50	5,000 ₺
KSN-İY-0013	K-3350	35,00 mm ²	16	30		Kırmızı	50	6,400 ₺
KSN-İY-0014	K-3500	50,00 mm ²	20	36		Mavi	25	12,000 ₺
KSN-İY-0015	K-3700	70,00 mm ²	20	37		Sarı	25	22,000 ₺





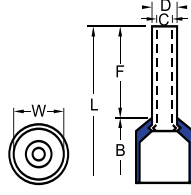











KSN®
KABLO UÇLARI

TEKNİK ÖZELLİKLER
Standart: DIN46228

Malzeme: Bakır, kalay kaplı

İzolasyon: Naylon

Çalışma Sıcaklığı: Maksimum 105 °C, 600 Volt arası

ÜRÜN KODU	TANIM	KESİT	BOYUTLAR		ALMAN RENK	KUTU ADEDİ	BİRİM FİYATI ₺	
			F	L				
KSN-İY-0016	K-2002	0,25mm ²	8	12		Turkuaz	1.000	1,150 ₺
KSN-İY-0017	K-2003	0,34 mm ²	8	12		Turkuaz	1.000	1,150 ₺
KSN-İY-0018	K-2005	0,50 mm ²	8	12		Turuncu	1.000	0,530 ₺
KSN-İY-0019	K-2007	0,75 mm ²	8	14		Beyaz	1.000	0,530 ₺
KSN-İY-0020	K-2010	1,00 mm ²	8	14		Sarı	1.000	0,530 ₺
KSN-İY-0021	K-2015	1,50 mm ²	8	14		Kırmızı	1.000	0,590 ₺
KSN-İY-0022	K-2025	2,50 mm ²	8	14		Mavi	500	0,750 ₺
KSN-İY-0023	K-2040	4,00 mm ²	10	17		Gri	500	1,270 ₺
KSN-İY-0024	K-2060	6,00 mm ²	12	20		Siyah	250	1,760 ₺
KSN-İY-0025	K-2100	10,00 mm ²	12	22		Bej	100	2,200 ₺
KSN-İY-0026	K-2160	16,00 mm ²	12	24		Yeşil	100	3,100 ₺
KSN-İY-0027	K-2250	25,00 mm ²	16	28		Kahve	50	5,000 ₺
KSN-İY-0028	K-2350	35,00 mm ²	16	30		Bej	50	6,400 ₺
KSN-İY-0029	K-2500	50,00 mm ²	20	36		Yeşil	25	12,000 ₺
KSN-İY-0030	K-2700	70,00 mm ²	20	37		Sarı	25	22,000 ₺



KSN® İZOLELİ ÇİFT GİRİŞ YÜKSÜKLER

FRANSIZ NORMU

İTHALATIMIZ

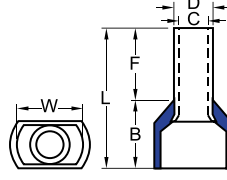

TEKNİK ÖZELLİKLER

Standart: DIN46228

Malzeme: Bakır, kalay kaplı

İzolasyon: Naylon

Çalışma Sıcaklığı: Maksimum 105 °C, 600 Volt arası

ÜRÜN KODU	TANIM	KESİT	BOYUTLAR		FRANSIZ RENK	KUTU ADEDİ	BİRİM FİYATI ₺	
			F	L				
KSN-İY-0031	K-23005	2 x 0,50 mm ²	8	14		Beyaz	1.000	0,950 ₺
KSN-İY-0032	K-23007	2 x 0,75 mm ²	8	14		Mavi	500	1,000 ₺
KSN-İY-0033	K-23010	2 x 1,00 mm ²	8	14		Kırmızı	500	1,050 ₺
KSN-İY-0034	K-23015	2 x 1,50 mm ²	8	14		Siyah	500	1,300 ₺
KSN-İY-0035	K-23025	2 x 2,50 mm ²	8	14		Gri	250	2,100 ₺
KSN-İY-0036	K-23040	2 x 4,00 mm ²	10	17		Turuncu	200	2,450 ₺
KSN-İY-0037	K-23060	2 x 6,00 mm ²	12	20		Yeşil	100	3,000 ₺
KSN-İY-0038	K-23100	2 x 10,00 mm ²	12	27		Kahverengi	50	4,670 ₺
KSN-İY-0039	K-23160	2 x 16,00 mm ²	12	31		Bej	50	6,000 ₺

KSN® İZOLELİ ÇİFT GİRİŞ YÜKSÜKLER

ALMAN NORMU

İTHALATIMIZ

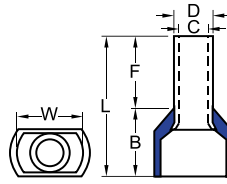

TEKNİK ÖZELLİKLER

Standart: DIN46228

Malzeme: Bakır, kalay kaplı

İzolasyon: Naylon

Çalışma Sıcaklığı: Maksimum 105 °C, 600 Volt arası

ÜRÜN KODU	TANIM	KESİT	BOYUTLAR		ALMAN RENK	KUTU ADEDİ	BİRİM FİYATI ₺	
			F	L				
KSN-İY-0040	K-22005	2 x 0,50 mm ²	8	14		Turuncu	1.000	0,950 ₺
KSN-İY-0041	K-22007	2 x 0,75 mm ²	8	14		Beyaz	500	1,000 ₺
KSN-İY-0042	K-22010	2 x 1,00 mm ²	8	14		Sarı	500	1,050 ₺
KSN-İY-0043	K-22015	2 x 1,50 mm ²	8	14		Kırmızı	500	1,300 ₺
KSN-İY-0044	K-22025	2 x 2,50 mm ²	8	14		Mavi	250	2,100 ₺
KSN-İY-0045	K-22040	2 x 4,00 mm ²	10	17		Gri	200	2,450 ₺
KSN-İY-0046	K-22060	2 x 6,00 mm ²	12	20		Siyah	100	3,000 ₺
KSN-İY-0047	K-22100	2 x 10,00 mm ²	12	27		Bej	50	4,670 ₺
KSN-İY-0048	K-22160	2 x 16,00 mm ²	12	31		Yeşil	50	6,000 ₺

KSN® İZOLESİZ KABLO YÜKSÜKLERİ

İTHALATIMIZ

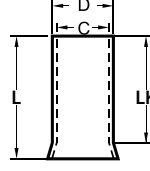

TEKNİK ÖZELLİKLER

Standart: DIN46228

Malzeme: Bakır, kalay kaplı

ÜRÜN KODU	TANIM	KESİT	BOYUTLAR				KUTU ADEDİ	LİSTE FİYATI ₺
			L	LK	C	D		
KSN-İZ-001	K-0,50	0,50 mm ²	10	8	1,0	1,3	2.000	0,530 ₺
KSN-İZ-002	K-0,75	0,75 mm ²	10	8	1,2	1,5	2.000	0,530 ₺
KSN-İZ-003	K-1,00	1,00 mm ²	10	8	1,4	1,7	2.000	0,530 ₺
KSN-İZ-004	K-1,50	1,50 mm ²	10	8	1,7	2,0	2.000	0,590 ₺
KSN-İZ-005A	K-2,50/8	2,50 mm ²	8	8	2,3	2,6	1.000	1,000 ₺
KSN-İZ-005	K-2,50	2,50 mm ²	12	8	2,3	2,6	1.000	0,830 ₺
KSN-İZ-006	K-4,00	4,00 mm ²	12	10	2,8	3,2	1.000	1,120 ₺
KSN-İZ-007	K-6,00	6,00 mm ²	12	10	3,5	3,9	500	1,150 ₺
KSN-İZ-008	K-10,00	10,00 mm ²	12	12	4,5	4,9	200	2,530 ₺
KSN-İZ-009	K-16,00	16,00 mm ²	15	12	5,8	6,2	200	3,100 ₺
KSN-İZ-010	K-25,00	25,00 mm ²	16	16	7,5	7,9	100	4,750 ₺
KSN-İZ-011	K-35,00	35,00 mm ²	16	16	8,3	8,7	100	5,500 ₺
KSN-İZ-012	K-50,00	50,00 mm ²	20	20	10,3	10,9	50	14,500 ₺

YÜKSÜK SETİ

FASTON TİP DİŞİ/ERKEK SET



ÜRÜN KODU	CİNSİ	FİYATI \$/ Ad.
HWA-274C	Yüksük Seti 1200 Parça, 8 Boy, 6 Renk	12,00 \$

ÜRÜN KODU	CİNSİ	FİYATI \$/ Ad.
HWA-274F	İzoleli Faston Dişi/Erkek 200 Parça, 3 Boy, 3 Renk	11,00 \$

KSN® YUVARLAK TİP İZOLELİ KABLO UÇLARI

İTHALATIMIZ

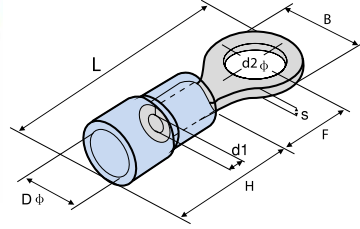

TEKNİK ÖZELLİKLER

Standart: DIN4 6237

Malzeme: Bakır, kalay kaplı

İzolasyon: PVC

Çalışma Sıcaklığı: Maksimum 105 °C, 600 Volt

Naylon kovanın eşsiz huni şekli, iletken kablunun %100 kolay girişini sağlar.

ÜRÜN KODU	RENK	Kablo Kesiti	Civata Ölçüsü	Ölçüler (mm)								Ambalaj Adedi	BİRİM FİYATI ₺
				d2	B	L	F	d1	D	H	s		
KYK-301		0,50 - 1,50 mm ²	M3	3,2	5,7	17,8	4,95	1,6	4,3	10	0,8	200	1,600 ₺
KYK-351			M3,5	3,5	5,7	17,8	4,95					200	2,250 ₺
KYK-401			M4	4,3	8,0	21,5	7,0					200	2,570 ₺
KYK-501			M5	5,3	9,8	23,0	8,5					200	2,880 ₺
KYK-601			M6	6,4	11,6	27,5	11,1					200	4,130 ₺
KYK-801			M8	8,4	11,6	27,5	11,1					200	4,200 ₺
KYK-302		1,50 - 2,50 mm ²	M3	3,2	6,6	17,8	4,3	2,3	4,9	10,0	0,8	200	3,100 ₺
KYK-402			M4	4,3	8,5	22,5	7,75					200	3,200 ₺
KYK-502			M5	5,3	9,5	22,5	7,25					200	3,300 ₺
KYK-602			M6	6,5	12,0	27,6	11,0					200	4,600 ₺
KYK-802			M8	8,4	12,0	27,6	11,0					200	4,700 ₺
KYK-1002			M10	10,5	13,6	30,2	13,9					100	4,200 ₺
KYK-1202			M12	13,0	19,2	25,0	16,5					100	7,500 ₺
KYK-406		4,00 - 6,00 mm ²	M4	4,3	7,2	21,4	5,9	3,6	6,7	13,0	1,0	100	6,650 ₺
KYK-506			M5	5,3	9,5	25,5	8,3					100	6,720 ₺
KYK-606			M6	6,4	12,0	31,5	13,0					100	7,600 ₺
KYK-806			M8	8,4	15,0	33,7	13,7					100	9,840 ₺
KYK-1006			M10	10,5	15,0	33,7	13,7					100	10,000 ₺
KYK-1206			M12	13,0	19,2	38,1	16,0					100	10,300 ₺
KYK-610		6,00 - 10,00 mm ²	M6	6,4	12,0	32,5	9,2	4,5	8,3	17,5	1,2	100	11,300 ₺
KYK-810			M8	8,4	15,0	38,7	13,8					100	14,000 ₺
KYK-1010			M10	10,5	15,0	38,7	13,8					100	16,480 ₺

KSN® ÇATAL TİP İZOLELİ KABLO UÇLARI

İTHALATIMIZ

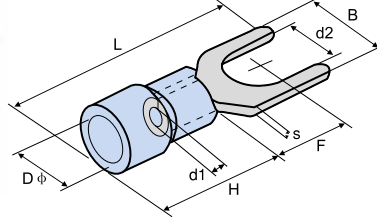











TEKNİK ÖZELLİKLER
Standart: DIN4 6237

Malzeme: Bakır, kalay kaplı

İzolasyon: PVC

Çalışma Sıcaklığı: Maksimum 105 °C, 600 Volt

Naylon kovanın eşsiz huni şekli, iletken kablunun %100 kolay girişini sağlar.

ÜRÜN KODU	RENK	Kablo Kesiti	Civata Ölçüsü	Ölçüler (mm)								Ambalaj Adedi	BİRİM FİYATI ₺
				d2	B	L	F	d1	D	H	s		
KÇK-3001		0,50 ~ 1,50 mm ² 22 ~ 16 AWG	M3	3,2	5,7	21,2	6,5	1,6	4,3	10,0	0,8	200	2,400 ₺
KÇK-4001			M4	4,3	6,4	21,2	6,5					200	2,420 ₺
KÇK-5001			M5	5,3	9,5	21,2	6,5					200	2,880 ₺
KÇK-6001			M6	6,4	12,0	27,2	11,0					200	4,150 ₺
KÇK-3002		1,50 ~ 2,50 mm ² 16 ~ 14 AWG	M3	3,2	5,7	21,2	6,5	2,3	4,9	10,0	0,8	200	2,800 ₺
KÇK-4002			M4	4,3	7,2	21,2	6,5					200	2,870 ₺
KÇK-5002			M5	5,3	9,5	21,2	6,5					200	3,150 ₺
KÇK-6002			M6	6,4	12,0	21,2	11,0					200	4,650 ₺
KÇK-4006		4,00 ~ 6,00 mm ² 12 ~ 10 AWG	M4	4,3	8,3	25,2	7,5	3,6	6,7	13,0	1,0	100	6,100 ₺
KÇK-5006			M5	5,3	9,0	25,2	7,5					100	6,120 ₺
KÇK-6006			M6	6,4	12,0	31,2	12,0					100	8,300 ₺
KÇK-8006			M8	8,4	14,0	30,0	11,5					100	9,500 ₺

KSN® DIŞI FASTON TİP İZOLELİ KABLO UÇLARI

İTHALATIMIZ





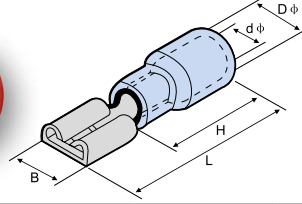







EKSTRA
BAKIR
YÜKSÜK



TEKNİK ÖZELLİKLER

Malzeme: Pirinç, kalay kaplı, bakır yüksüklü
İzolasyon: PVC
Çalışma Sıcaklığı: Maksimum 75 °C, 300 Volt

ÜRÜN KODU	RENK	Kablo Kesiti	Soket Geniřlięi	Ölçüler (mm)					Kutu Adedi	BİRİM FİYATI ₺
				B	D	d	L	H		
KFD-1288/5		0,50 - 1,50 mm ² 22 ~ 16 AWG	0,5 x 2,80	3,8	3,8	1,7	19,0	10,0	200	3,580 ₺
KFD-1288			0,8 x 2,80	3,8	3,8	1,7	19,0	10,0	200	3,580 ₺
KFD-1488/5			0,5 x 4,75	5,6	3,8	1,7	19,0	10,0	200	4,000 ₺
KFD-1488			0,8 x 4,75	5,6	3,8	1,7	19,0	10,0	200	4,000 ₺
KFD-1638			0,8 x 6,35	7,4	3,8	1,7	21,0	10,0	200	4,800 ₺
KFD-2288		1,50 - 2,50 mm ² 16 ~ 14 AWG	0,8 x 2,80	3,8	4,3	2,3	19,0	10,0	200	4,480 ₺
KFD-2488			0,8 x 4,75	5,6	4,3	2,3	19,0	10,0	200	5,000 ₺
KFD-2638			0,8 x 6,35	7,4	4,3	2,3	21,0	10,0	200	5,600 ₺
KFD-5638		4,00 - 6,00 mm ² 12 ~ 10 AWG	0,8 x 6,35	7,4	5,7	3,4	25,0	13,0	100	7,600 ₺
KFD-5956			1,2 x 9,40	10,0	6,2	3,4	28,6	13,0	100	12,750 ₺

KSN® DIŞI FASTON TİP TAM İZOLELİ KABLO UÇLARI

İTHALATIMIZ





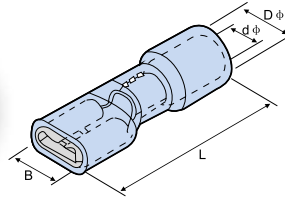



EKSTRA
BAKIR
YÜKSÜK



TEKNİK ÖZELLİKLER

Malzeme: Pirinç, kalay kaplı, bakır yüksüklü
İzolasyon: PVC
Çalışma Sıcaklığı: Maksimum 75 °C, 300 Volt

ÜRÜN KODU	RENK	Kablo Kesiti	Soket Geniřlięi	Ölçüler (mm)				Kutu Adedi	BİRİM FİYATI ₺
				B	D	d	L		
KFFD-1488/5		0,50 ~ 1,50 mm ² 22 ~ 16 AWG	0,5 x 4,75	5,6	3,8	1,7	20,0	200	4,800 ₺
KFFD-1488			0,8 x 4,75	5,6	3,8	1,7	20,0	200	4,800 ₺
KFFD-1638			0,8 x 6,35	7,4	3,8	1,7	21,5	100	5,450 ₺
KFFD-2488		1,50 ~ 2,50 mm ² 16 ~ 14 AWG	0,8 x 4,75	5,6	4,3	2,3	20,0	100	5,600 ₺
KFFD-2638			0,8 x 6,35	7,4	4,3	2,3	21,5	100	6,400 ₺
KFFD-5638		4,00 ~ 6,00 mm ² 12 ~ 10 AWG	0,8 x 6,35	7,4	5,7	3,4	25,5	100	8,320 ₺

KSN® DIŞI FASTON TİP TAM İZOLELİ POLYAMİD KABLO UÇLARI

İTHALATIMIZ



EKSTRA
BAKIR
YÜKSÜK

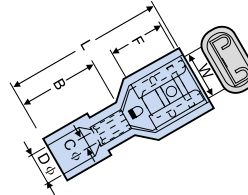

TEKNİK ÖZELLİKLER

Malzeme: Pirinç, kalay kaplı, bakır yüksüklü
İzolasyon: Polyamid
Çalışma Sıcaklığı: Maksimum 105 °C, 300 Volt

ÜRÜN KODU	RENK	Kablo Kesiti	Soket Geniřlięi	Ölçüler (mm)						Kutu Adedi	BİRİM FİYATI ₺
				W	F	L	B	D	C		
KPFD-1638		0,50 ~ 1,50 mm ² 22 ~ 16 AWG	0,8 x 6,35	6,6	7,3	22,0	11,0	4,0	1,7	100	9,250 ₺
KPFD-2638		1,50 ~ 2,50 mm ² 16 ~ 14 AWG	0,8 x 6,35	6,6	7,3	22,0	11,0	4,5	2,3	100	9,500 ₺
KPFD-5638		4,00 ~ 6,00 mm ² 12 ~ 10 AWG	0,8 x 6,35	6,6	7,3	24,0	13,0	6,3	3,4	100	11,200 ₺

KSN® ERKEK FASTON TİP İZOLELİ KABLO UÇLARI

İTHALATIMIZ

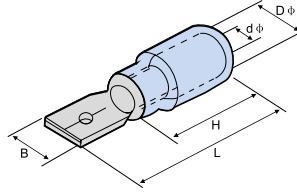
 EKSTRA
BAKIR
YÜKSÜK

TEKNİK ÖZELLİKLER

Malzeme: Pirinç, kalay kaplı, bakır yüksüklü
İzolasyon: PVC
Çalışma Sıcaklığı: Maksimum 75 °C, 300 Volt

ÜRÜN KODU	RENK	Kablo Kesiti	Soket Genişliği	Ölçüler (mm)					Kutu Adedi	BİRİM FİYATI ₺
				B	d	D	L	H		
KFE-1288		0,50 ~ 1,50 mm ² 22 ~ 16 AWG	0,8 x 2,80	2,8	1,7	4,3	17,7	10,0	200	4,000 ₺
KFE-1488			0,8 x 4,75	4,75	1,7	4,3	20,0	10,0	200	4,480 ₺
KFE-1638			0,8 x 6,35	6,35	1,7	4,3	21,0	10,0	200	4,680 ₺
KFE-2488		1,50 ~ 2,50 mm ² 16 ~ 14 AWG	0,8 x 4,75	4,75	2,3	4,3	20,0	10,0	200	5,230 ₺
KFE-2638			0,8 x 6,35	6,35	2,3	4,3	21,0	10,0	200	5,230 ₺
KFE-5638		4,00 ~ 6,00 mm ² 12 ~ 10 AWG	0,8 x 6,35	6,35	3,4	5,7	25,0	13,0	100	7,120 ₺

KSN® ERKEK/DİŞİ GERİ DÖNÜŞLÜ İZOLELİ KABLO UÇLARI

İTHALATIMIZ

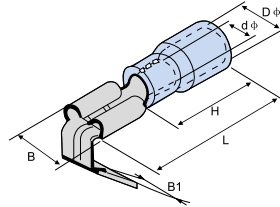
 EKSTRA
BAKIR
YÜKSÜK

TEKNİK ÖZELLİKLER

Malzeme: Pirinç, kalay kaplı, bakır yüksüklü
İzolasyon: PVC
Çalışma Sıcaklığı: Maksimum 75 °C, 300 Volt

ÜRÜN KODU	RENK	Kablo Kesiti	Soket Genişliği	Ölçüler (mm)						Kutu Adedi	BİRİM FİYATI ₺
				B	B1	L	H	D	d		
KFDEG-1861		1,50 ~ 2,50 mm ² 22 ~ 16 AWG	0,8 x 6,35	7,4	6,35	21,5	10,0	3,8	1,7	100	7,520 ₺
KFDEG-2862		1,50 ~ 2,50 mm ² 16 ~ 14 AWG	0,8 x 6,35	7,4	6,35	21,5	10,0	4,3	2,3	100	8,400 ₺
KFDEG-5866		4,00 ~ 6,00 mm ² 12 ~ 10 AWG	0,8 x 6,35	7,4	6,35	25,0	13,0	5,7	3,4	100	9,000 ₺

KSN® BAYRAK TİP TAM İZOLELİ POLYAMİD KABLO UÇLARI

İTHALATIMIZ

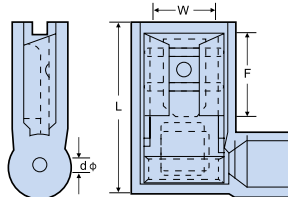
 EKSTRA
BAKIR
YÜKSÜK

TEKNİK ÖZELLİKLER

Malzeme: Pirinç, kalay kaplı, bakır yüksüklü
İzolasyon: PVC
Çalışma Sıcaklığı: Maksimum 75 °C, 300 Volt

ÜRÜN KODU	Kablo Kesiti	Soket Genişliği	Ölçüler (mm)				Kutu Adedi	BİRİM FİYATI ₺
			W	F	L	d		
KPFDEB-1861	0,50 - 1,50 mm ² 22 ~ 16 AWG	0,8 x 6,35	6,6	7,6	16	1,7	100	6,800 ₺
KPFDEB-2862	1,50 - 2,50 mm ² 16 ~ 14 AWG	0,8 x 6,35	6,6	7,6	16	2,3	100	7,000 ₺

KSN® İZOLELİ ERKEK TERMİNALLER

İTHALATIMIZ



EKSTRA
BAKIR
YÜKSÜK

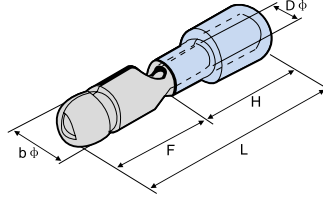

TEKNİK ÖZELLİKLER

Malzeme: Pirinç, kalay kaplı, bakır yüksüklü
İzolasyon: PVC
Çalışma Sıcaklığı: Maksimum 75 °C, 300 Volt

ÜRÜN KODU	Kablo Kesiti	Ölçüler (mm)					Kutu Adedi	BİRİM FİYATI ₺
		b	F	L	H	D		
KBE-1040	0,50 ~ 1,50 mm ² 22 ~ 16 AWG	4,0	11,0	21,0	10,0	1,7	200	6,000 ₺
KBE-2040	1,50 ~ 2,50 mm ² 16 ~ 14 AWG	4,0	11,0	21,0	10,0	2,3	200	6,200 ₺
KBE-2050		5,0	11,0	21,0	10,0	2,3	200	7,000 ₺
KBE-5050	4,00 ~ 6,00 mm ² 12 ~ 10 AWG	5,0	12,0	25,0	13,0	3,4	100	9,100 ₺

KSN® İZOLELİ DIŞI TERMİNALLER

İTHALATIMIZ



EKSTRA
BAKIR
YÜKSÜK

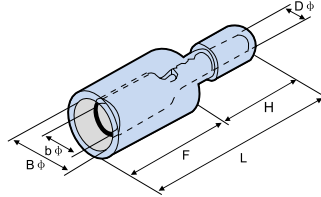

TEKNİK ÖZELLİKLER

Malzeme: Pirinç, kalay kaplı, bakır yüksüklü
İzolasyon: PVC
Çalışma Sıcaklığı: Maksimum 75 °C, 300 Volt

ÜRÜN KODU	Kablo Kesiti	Ölçüler (mm)					Kutu Adedi	BİRİM FİYATI ₺
		b	F	L	H	D		
KBD-1040	0,50 ~ 1,50 mm ² 22 ~ 16 AWG	4,0	6,3	24,5	13,0	1,7	100	7,100 ₺
KBD-2040	1,50 ~ 2,50 mm ² 16 ~ 14 AWG	4,0	6,3	24,5	14,0	2,3	100	7,200 ₺
KBD-2050		5,0	7,0	25,5	14,0	2,3	100	8,100 ₺
KBD-5050	4,00 ~ 6,00 mm ² 12 ~ 10 AWG	5,0	7,0	29,5	14,0	3,4	100	10,000 ₺

KSN® İZOLELİ KABLO UCU EK MUFLARI

İTHALATIMIZ

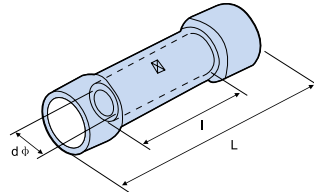

TEKNİK ÖZELLİKLER

Malzeme: Bakır, kalay kaplı
İzolasyon: PVC
Çalışma Sıcaklığı: Maksimum 105 °C, 600 Volt

ÜRÜN KODU	RENK	Kablo Kesiti	Ölçüler (mm)			Kutu Adedi	BİRİM FİYATI ₺
			L	d	l		
KBY-251		0,50 ~ 1,50 mm ² 22 ~ 16 AWG	26,0	1,7	15,0	200	3,700 ₺
KBY-252		1,50 ~ 2,50 mm ² 16 ~ 14 AWG	26,0	2,3	15,0	200	4,900 ₺
KBY-256		4,00 ~ 6,00 mm ² 12 ~ 10 AWG	26,0	3,4	15,0	100	9,300 ₺

KSN® İĞNE TİP İZOLELİ KABLO UÇLARI

İTHALATIMIZ

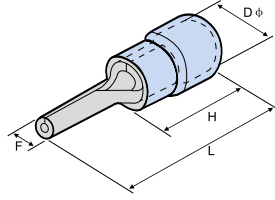

TEKNİK ÖZELLİKLER

Malzeme: Bakır, kalay kaplı

İzolasyon: PVC

Çalışma Sıcaklığı: Maksimum 105 °C, 600 Volt

ÜRÜN KODU	RENK	Kablo Kesiti	Ölçüler (mm)						Kutu Adedi	BİRİM FİYATI ₺
			F	L	H	D	d1	Kalınlık		
KİK-101		0,50 ~ 1,50 mm ² 22 ~ 16 AWG	1,9	19	10,0	4,3	1,7	0,75	200	2,800 ₺
KİK-102		1,50 ~ 2,50 mm ² 16 ~ 14 AWG	1,9	22,0	10,0	4,9	2,3	0,80	200	3,400 ₺
KİK-106		4,00 ~ 6,00 mm ² 12 ~ 10 AWG	2,8	25,5	13,0	6,7	3,4	1,00	100	8,000 ₺

KSN® BIÇAK TİP İZOLELİ KABLO UÇLARI

İTHALATIMIZ

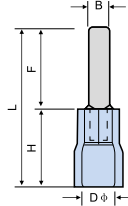

TEKNİK ÖZELLİKLER

Malzeme: Bakır, kalay kaplı

İzolasyon: PVC

Çalışma Sıcaklığı: Maksimum 105 °C, 600 Volt

ÜRÜN KODU	Kablo Kesiti	Ölçüler (mm)					Kutu Adedi	BİRİM FİYATI ₺
		B	L	F	H	D		
KİK-101/14	0,50 - 1,50 mm ² 22 ~ 16 AWG	2,3	24	14	10	4,3	100	3,000 ₺
KİK-102/18	1,50 - 2,50 mm ² 16 ~ 14 AWG	2,3	28	18	10	4,9	100	4,300 ₺

KSN® UCU KIVRIK BIÇAK TİP İZOLELİ KABLO UÇLARI

İTHALATIMIZ

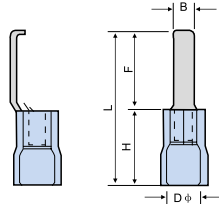

TEKNİK ÖZELLİKLER

Malzeme: Bakır, kalay kaplı

İzolasyon: PVC

Çalışma Sıcaklığı: Maksimum 105 °C, 600 Volt

ÜRÜN KODU	RENK	Kablo Kesiti	Ölçüler (mm)					Kutu Adedi	BİRİM FİYATI ₺
			B	L	F	H	D		
KLBV-1.25-3		0,50 ~ 1,50 mm ² 22 ~ 16 AWG	3,0	26,8	16,8	10,0	4,3	200	4,560 ₺
KLBV-1.25-4.6			4,6	26,8	16,8	10,0	4,3	200	5,440 ₺
KLBV-2-3		1,50 ~ 2,50 mm ² 16 ~ 14 AWG	3,0	26,8	16,8	10,0	4,9	100	4,200 ₺
KLBV-2-4.6			4,6	26,8	16,8	10,0	4,9	100	7,000 ₺
KLBV-5.5-4.6		4,00 ~ 6,00 mm ² 12 ~ 10 AWG	4,6	29,3	16,8	13,0	6,7	100	9,750 ₺

KSN® ISI BÜZÜŞMELİ EK MUF

İTHALATIMIZ

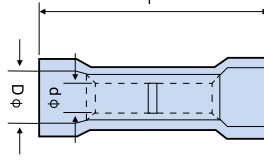

TEKNİK ÖZELLİKLER

Malzeme: Bakır, kalay kaplı

İzolasyon: Isı ile daralan makaron

Çalışma Sıcaklığı: Maksimum 105 °C, 600 Volt

ÜRÜN KODU	RENK	Kablo Kesiti	Ölçüler (mm)			Poşet Adedi	BİRİM FİYATI ₺
			L	d	D		
KBHT-1		0.5 ~ 1.5 mm ² 22 ~ 16 AWG	26.0	1.8	4.2	100	12,800 ₺
KBHT-2		1.5 ~ 2.5 mm ² 16 ~ 14 AWG	26.0	2.4	4.8	100	13,200 ₺
KBHT-3		4.0 ~ 6.0 mm ² 12 ~ 10 AWG	27.0	3.6	4.8	100	20,000 ₺

KSN® ISI BÜZÜŞMELİ EK MUF (LEHİMLİ)

İTHALATIMIZ



ÜRÜN KODU	RENK	Kablo Kesiti	Poşet Adedi	BİRİM FİYATI \$
BHTS-0.5	 Beyaz	0,25 - 0,34 mm ²	100	0,080 \$
BHTS-1	 Kırmızı	0,50 - 1,50 mm ²	100	0,100 \$
BHTS-2	 Mavi	1,50 - 2,50 mm ²	100	0,120 \$
BHTS-5	 Sarı	4,00 - 6,00 mm ²	100	0,145 \$

AYDINLATMA İÇİN KABLO SOKETLER

IP 67 DIŞ MEKAN BAĞLANTI ELEMANI

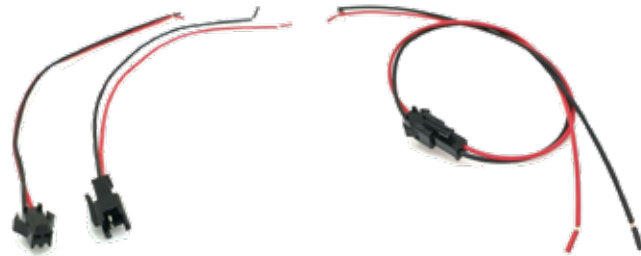

ÜRÜN KODU	CİNSİ	FİYATI \$ / TK.
KON-305	15 cm Kablolü Soket	0,16 \$ / NET
KON-305A	20 cm Kablolü Soket	0,18 \$ / NET

ÜRÜN KODU	CİNSİ	FİYATI \$ / Ad.
KON-282	IP67 Dış Mekan Bağlantı Klemensi Su Geçirmez	1,00 \$ / NET

KSN® VIDALI BUAT KLEMENSLERİ

İTHALATIMIZ

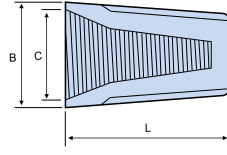

TEKNİK ÖZELLİKLER

Malzeme: Pirinç, kalay kaplı

İzolasyon: PVC

Çalışma Sıcaklığı: Maksimum 105 °C, 600 Volt

ÜRÜN KODU	RENK	Ölçüler (mm)			Poşet Adedi	BİRİM FİYATI ₺
		B	C	L		
KP-1		8,5	6,7	15,0	100	1,150 ₺
KP-2		10,1	7,4	17,5	100	1,360 ₺
KP-3		12,6	9,9	22,1	100	2,300 ₺
KP-4		13,7	11,0	24,5	100	3,000 ₺
KP-6		16,0	13,0	26,5	100	4,650 ₺

KSN® HIZLI KABLO EKLEME PARÇASI

İTHALATIMIZ

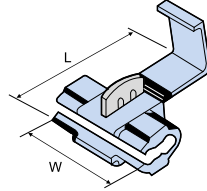

TEKNİK ÖZELLİKLER

Malzeme: Pirinç, kalay kaplı

İzolasyon: Naylon

Çalışma Sıcaklığı: Maksimum 105 °C, 600 Volt

ÜRÜN KODU	RENK	Kablo Kesiti	Ölçüler (mm)		Poşet Adedi	BİRİM FİYATI ₺
			W	L		
KSP-1		0.5 ~ 1.0	20,0	27,0	1000	4,000 ₺
KSP-2		1.0 ~ 2.5	20,0	27,0	1000	4,000 ₺
KSP-5		4.0 ~ 6.0	20,5	34,5	500	6,500 ₺

İKİ TARAF BASMALI KLEMENSLER



KOD	CİNSİ	AD. / ₺
KON-296	No.1 İkili Vidasız Klemens	3,50 ₺
KON-297	No.1 Üçlü Vidasız Klemens	5,00 ₺

İKİ TARAFLI MANDALLI KLEMENSLER



KOD	CİNSİ	K. KESİTİ	K. ADEDİ	AD. / ₺
KCT-1	1-1'Lİ	0,2-4 mm ²	50	19,30 ₺
KCT-2	1-2'Lİ	0,2-4 mm ²	50	34,00 ₺
KCT-3	1-3'Lİ	0,2-4 mm ²	50	44,30 ₺
KCT-4	1-4'LÜ	0,2-4 mm ²	50	45,00 ₺
KCT-5	1-5'Lİ	0,2-4 mm ²	50	55,00 ₺

KOMPAKT ÇOK AMAÇLI KLEMENSLER

MADE IN CHINA



Gövde malzeme: Polikarbon
Kablo kesiti: 0,2-4,00 mm²/24-12 AWG
Kablo soyma uzunluğu: 11 mm
Sürekli çalışma sıcaklığı: Max. 105 °C
Ortam sıcaklığı: Max. 85 °C
Nominal akım: 32 A
Nominal gerilim: 450 V
Not: Tırnakları kaldırmadan,
kablونuzu ileriye iterek kolay montaj imkanı.

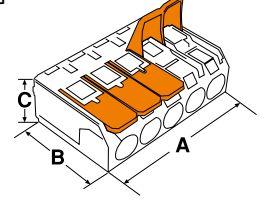

ÜRÜN KODU	AÇIKLAMA	Kablo Kesiti	K. ADET	ADET (₺)
KPCG-622	2 İletken Bağlantılı	0,2 - 4 mm ²	100	14,00 ₺
KPCG-623	3 İletken Bağlantılı	0,2 - 4 mm ²	100	17,00 ₺
KPCG-624	4 İletken Bağlantılı	0,2 - 4 mm ²	100	20,00 ₺
KPCG-625	5 İletken Bağlantılı	0,2 - 4 mm ²	100	25,00 ₺

İNCE MANDALLI AÇILABİLİR BUAT KLEMENSLERİ

MADE IN CHINA



ÜRÜN KODU	Kutup Sayısı	Kablo Kesiti	Ölçüler (mm)			Poşet Adedi	Adet Fiyatı (₺)
			A	B	H		
KPCİ-622	2	0,2-4 mm ²	12,2	20,7	14,5	500	16,50 ₺
KPCİ-623	3	0,2-4 mm ²	16,8	20,7	14,5	500	18,20 ₺
KPCİ-625	5	0,2-4 mm ²	26,0	20,7	14,5	300	31,00 ₺

TEK DAMAR İLETKENLER İÇİN BUAT KLEMENSLER

MADE IN CHINA



ÜRÜN KODU	RENK	KUTUP SAYISI	KABLO KESİTİ	K. / AD.	ADET (₺)
KSDK - 2	○ Beyaz	2	2,5 mm ²	100	6,30 ₺
KSDK - 3	● Turuncu	3	2,5 mm ²	100	7,20 ₺
KSDK - 4	● Kırmızı	4	2,5 mm ²	100	8,00 ₺
KSDK - 5	● Sarı	5	2,5 mm ²	100	9,00 ₺
KSDK - 6	● Mavi	6	2,5 mm ²	250	12,00 ₺
KSDK - 8	● Gri	8	2,5 mm ²	200	13,00 ₺



221 SERİSİ KOMPAKT ÇOK AMAÇLI KLEMENS

Tüm Kablo Çeşitleri İçin

ÜRÜN KODU	AÇIKLAMA	K. / AD.	ADET (€)
KSN-412	2 İletken Bağlantılı / 2x4 mm ²	100	0,59 €
KSN-413	3 İletken Bağlantılı / 3x4 mm ²	50	0,73 €
KSN-415	5 İletken Bağlantılı / 5x4 mm ²	25	1,17 €



- Nominal akım: 32 A
- Sürekli çalışma sıcaklığı: Maks. 105 °C
- Nominal gerilim: 450 V
- Ortam sıcaklığı: aks. 85 °C (T85)
- Yüksek sıcaklıklar için
- 0,14-4 mm² (24-12 AWG)
- 0,2-4 mm² (24-12 AWG)

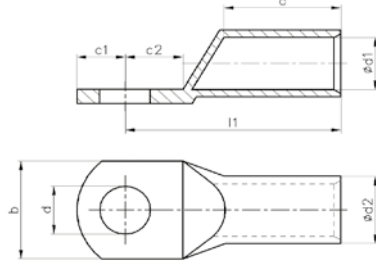

KSN® STANDART TİP SIKMALI KABLO PABUÇLARI
İMALATIMIZ

TEKNİK ÖZELLİKLER

Malzeme: EN 13600 Bakır
Kaplama: Kalay kaplı

ÜRÜN KODU	Kablo Kesiti mm ²	Civata Deliği	Boyutlar (mm)								Kutu Miktarı (Adet)	BİRİM FİYATI ₺
			d	d1	d2	l1	a	b	c1	c2		
KSNSKPS-01005	10 mm ²	M5	5,5	4,5	6,5	22,0	11,5	10,0	7,0	7,0	800	20,500 ₺
KSNSKPS-01006		M6	6,5	1,5	6,5	22,0	11,5	11,0	7,0	7,0	800	20,500 ₺
KSNSKPS-01008		M8	8,5	4,5	6,5	23,0	11,5	13,5	8,0	8,0	800	20,500 ₺
KSNSKPS-01606	16 mm ²	M6	6,5	5,5	7,5	24,0	12,5	12,0	7,5	7,5	500	28,000 ₺
KSNSKPS-01608		M8	8,5	5,5	7,5	25,5	13,0	13,5	8,0	8,0	500	30,000 ₺
KSNSKPS-01610		M10	10,5	5,5	7,5	25,5	13,0	13,5	9,0	9,0	500	30,000 ₺
KSNSKPS-02506	25 mm ²	M6	6,5	7,0	9,5	30,5	17,0	14,0	8,5	8,5	300	48,000 ₺
KSNSKPS-02508		M8	8,5	7,0	9,5	30,5	17,0	14,0	8,5	8,5	300	48,000 ₺
KSNSKPS-02510		M10	10,5	7,0	9,5	31,5	17,0	16,0	10,0	10,0	300	52,000 ₺
KSNSKPS-03506	35 mm ²	M6	6,5	8,5	11,0	24,5	19,0	16,0	9,5	9,5	200	69,000 ₺
KSNSKPS-03508		M8	8,5	8,5	11,0	34,5	19,0	16,5	9,5	9,5	200	69,000 ₺
KSNSKPS-03510		M10	10,5	8,5	11,0	35,0	19,0	16,5	10,0	10,0	200	73,000 ₺
KSNSKPS-03512		M12	13,0	8,5	11,0	37,0	19,0	18,0	11,0	11,0	200	73,000 ₺
KSNSKPS-05006	50 mm ²	M6	6,5	10,0	13,0	40,0	21,0	19,0	11,0	11,0	150	100,000 ₺
KSNSKPS-05008		M8	8,5	10,0	13,0	40,0	21,0	19,0	11,0	11,0	150	100,000 ₺
KSNSKPS-05010		M10	10,5	10,0	13,0	40,0	21,0	19,0	11,0	11,0	150	105,000 ₺
KSNSKPS-05012		M12	13,0	10,0	13,0	40,0	21,0	19,0	11,0	11,0	150	105,000 ₺
KSNSKPS-07008	70 mm ²	M8	8,5	11,5	14,5	41,5	23,0	21,5	11,0	11,0	100	143,000 ₺
KSNSKPS-07010		M10	10,5	11,5	14,5	41,5	23,0	21,5	11,0	11,0	100	143,000 ₺
KSNSKPS-07012		M12	13,0	11,5	14,5	41,5	23,0	21,5	11,0	11,0	100	143,000 ₺
KSNSKPS-07014		M14	15,0	11,5	14,5	43,5	23,0	23,0	13,0	13,0	100	160,000 ₺
KSNSKPS-07016		M16	17,0	11,5	14,5	46,5	23,0	23,0	16,0	16,0	100	160,000 ₺

* Ürünlerimiz elektrolitik bakırdan (E-Cu), ekstra cam tavli, çapaksız havşalı ve minimum 3 mikron kalay kaplıdır.

* Firmamız önceden haber vermeden ürün ölçülerinde değişiklik yapma hakkını saklı tutar.

KSN® STANDART TİP SIKMALI KABLO PABUÇLARI

İMALATIMIZ

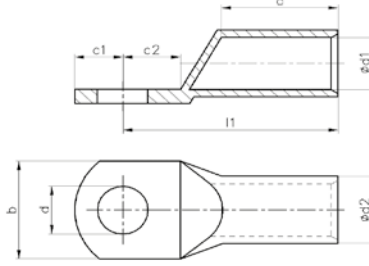

TEKNİK ÖZELLİKLER

Malzeme: EN 13600 Bakır
Kaplama: Kalay kaplı

ÜRÜN KODU	Kablo Kesiti mm ²	Civata Deliği	Boyutlar (mm)								Kutu Miktarı (Adet)	BİRİM FİYATI ₺
			d	d1	d2	l1	a	b	c1	c2		
KSNSKPS-09508	95 mm ²	M8	8,5	13,5	16,5	48,0	26,0	24,0	12,0	12,5	80	175,000 ₺
KSNSKPS-09510		M10	10,5	13,5	16,5	48,0	26,0	24,0	12,0	12,5	80	175,000 ₺
KSNSKPS-09512		M12	13,0	13,5	16,5	48,0	26,0	24,0	12,0	12,5	80	175,000 ₺
KSNSKPS-09514		M14	15,0	11,5	14,5	50,0	26,0	26,0	14,0	14,0	80	202,000 ₺
KSNSKPS-09516		M16	17,0	11,5	14,5	52,0	26,0	26,0	16,0	16,0	80	202,000 ₺
KSNSKPS-12010	120 mm ²	M10	10,5	14,5	18,0	52,0	27,0	26,0	14,0	14,0	50	242,000 ₺
KSNSKPS-12012		M12	13,0	14,5	18,0	52,0	27,0	26,5	14,0	14,0	50	242,000 ₺
KSNSKPS-12014		M14	15,0	14,5	18,0	52,0	27,0	26,0	14,0	14,0	50	242,000 ₺
KSNSKPS-12016		M16	17,0	14,5	18,0	52,0	27,0	26,0	14,0	14,0	50	242,000 ₺
KSNSKPS-15010	150 mm ²	M10	10,5	16,5	21,0	57,0	30,0	30,5	15,0	15,0	30	390,000 ₺
KSNSKPS-15012		M12	13,0	16,5	21,0	57,0	30,0	30,5	15,0	15,0	30	390,000 ₺
KSNSKPS-15014		M14	15,0	16,5	21,0	57,0	30,0	30,5	15,0	15,0	30	390,000 ₺
KSNSKPS-15016		M16	17,0	16,5	21,0	57,0	30,0	30,5	15,0	15,0	30	390,000 ₺
KSNSKPS-18510	185 mm ²	M10	10,5	18,5	23,0	65,5	33,5	34,0	17,0	18,0	30	480,000 ₺
KSNSKPS-18512		M12	13,0	18,5	23,0	65,5	33,5	34,0	17,0	18,0	30	480,000 ₺
KSNSKPS-18514		M14	15,0	18,5	23,0	65,5	33,5	34,0	17,0	18,0	30	480,000 ₺
KSNSKPS-18516		M16	17,0	18,5	23,0	65,5	33,5	34,0	17,0	18,0	30	480,000 ₺
KSNSKPS-24010	240 mm ²	M10	10,5	21,0	26,0	72,0	39,0	38,0	17,0	18,0	25	630,000 ₺
KSNSKPS-24012		M12	13,0	21,0	26,0	72,0	39,0	38,0	17,0	18,0	25	630,000 ₺
KSNSKPS-24014		M14	15,0	21,0	26,0	72,0	39,0	38,0	17,0	18,0	25	630,000 ₺
KSNSKPS-24016		M16	17,0	21,0	26,0	72,0	39,0	38,0	17,0	18,0	25	630,000 ₺
KSNSKPS-30012	300 mm ²	M12	13,0	23,5	28,5	77,0	41,0	42,0	19,0	19,0	20	750,000 ₺
KSNSKPS-30014		M14	15,0	23,5	28,5	77,0	41,0	42,0	19,0	19,0	20	750,000 ₺
KSNSKPS-30016		M16	17,0	23,5	28,5	77,0	41,0	42,0	19,0	19,0	20	750,000 ₺

* Ürünlerimiz elektrolitik bakırdan (E-Cu), ekstra cam tavlı, çapaksız havşalı ve minimum 3 mikron kalay kaplıdır.

* Firmamız önceden haber vermeden ürün ölçülerinde değişiklik yapma hakkını saklı tutar.

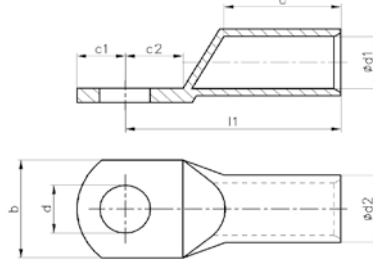
KSN® EKO TİP SIKMALI KABLO PABUÇLARI
İMALATIMIZ

TEKNİK ÖZELLİKLER

Malzeme: EN 13600 Bakır
Kaplama: Kalay kaplı

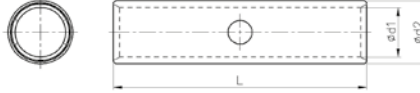
ÜRÜN KODU	Kablo Kesiti mm ²	Civata Deliği	Boyutlar (mm)								Kutu Miktarı (Adet)	BİRİM FİYATI ₺
			d	d1	d2	l1	a	b	c1	c2		
KSNSKPE-01606	10 mm ²	M5	5,5	4,5	6,0	22,0	11,5	9,0	7,0	7,0	800	19,800 ₺
KSNSKPE-01606	16 mm ²	M6	6,5	5,5	7,0	24,0	12,5	10,5	7,5	7,5	500	20,000 ₺
KSNSKPE-02508	25 mm ²	M8	8,5	7,0	9,0	30,5	17,5	14,0	8,5	8,5	300	35,000 ₺
KSNSKPE-03508	35 mm ²	M8	8,5	8,5	10,5	34,0	18,5	16,0	9,5	9,5	200	45,000 ₺
KSNSKPE-05010	50 mm ²	M10	10,5	10,0	12,0	39,5	20,0	18,0	11,0	11,0	150	58,000 ₺
KSNSKPE-07010	70 mm ²	M10	10,5	11,5	14,0	42,0	22,0	21,1	11,0	11,0	100	90,000 ₺
KSNSKPE-09510	95 mm ²	M12	10,5	13,5	16,0	48,0	25,0	24,5	12,0	12,5	80	112,000 ₺
KSNSKPE-12012	120 mm ²	M12	13,0	15,5	18,0	52,0	27,0	27,0	14,0	14,0	50	152,000 ₺
KSNSKPE-15012	150 mm ²	M12	13,0	16,5	20,0	54,5	29,0	29,0	14,0	14,0	30	270,000 ₺
KSNSKPE-18516	185 mm ²	M16	17,0	18,5	22,0	61,5	32,0	32,0	14,5	14,5	30	310,000 ₺
KSNSKPE-24016	240 mm ²	M16	17,0	21,5	25,0	69,0	36,5	37,5	16,0	16,0	25	425,000 ₺

KSN® EKO TİP EK MUFLAR
İMALATIMIZ

TEKNİK ÖZELLİKLER

Malzeme: EN 13600 Bakır
Kaplama: Kalay kaplı

ÜRÜN KODU	Kablo Kesiti mm ²	Boyutlar (mm)			Kutu Miktarı (Adet)	BİRİM FİYATI ₺
		d1	d2	L		
KSNEKMUF-010	10 mm ²	4,5	6,0	29,0	400	21,000 ₺
KSNEKMUF-016	16 mm ²	5,5	7,0	32,0	400	22,000 ₺
KSNEKMUF-025	25 mm ²	7,0	9,0	40,0	250	38,000 ₺
KSNEKMUF-035	35 mm ²	8,5	10,5	45,0	150	50,000 ₺
KSNEKMUF-050	50 mm ²	10,0	12,0	50,0	90	55,000 ₺
KSNEKMUF-070	70 mm ²	11,5	14,0	55,0	65	80,000 ₺
KSNEKMUF-095	95 mm ²	13,5	16,0	60,0	50	105,000 ₺
KSNEKMUF-120	120 mm ²	15,5	18,0	65,0	40	130,000 ₺
KSNEKMUF-150	150 mm ²	16,5	20,0	70,0	25	230,000 ₺
KSNEKMUF-185	185 mm ²	18,5	22,0	75,0	22	280,000 ₺
KSNEKMUF-240	240 mm ²	21,5	25,5	85,0	18	385,000 ₺

* Ürünlerimiz elektrolitik bakırdan (E-Cu), ekstra cam tavli, çapaksız havşalı ve minimum 3 mikron kalay kaplıdır.

* Firmamız önceden haber vermeden ürün ölçülerinde değişiklik yapma hakkını saklı tutar.

KSN® DIN 46234 TİP YUVARLAK (KAYNAKLI) KABLO PABUÇLARI

İTHALATIMIZ

RoHS
COMPLIANT

Özellikler

- DIN 46234 e göre üretilmiştir
- Sıkma alanında sert lehimli
- Gelişmiş sıkma özellikleri için oluklu profil

Malzeme : Cu-ETP
Yüzey : Kalay kaplı

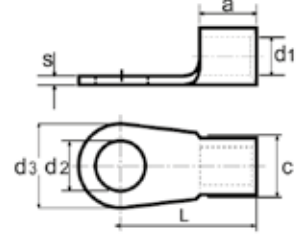

ÜRÜN KODU	Kablo Kesiti mm ²	Civata Ø	Boyutlar (mm)						Kutu Miktarı (Adet)	BİRİM FİYATI \$
			d3	L	a	c	d1	S		
KSNKYN-3-1	1,5	M3	8,0	12,0	5,0	4,0	1,6	0,8	1.000	0,106 \$
KSNKYN-4-1		M4	8,0	12,0	5,0	4,0	1,6	0,8	1.000	0,106 \$
KSNKYN-5-1		M5	10,0	13,0	5,0	4,0	1,6	0,8	1.000	0,119 \$
KSNKYN-6-1		M6	10,0	13,0	5,0	4,0	1,6	0,8	1.000	0,133 \$
KSNKYN-4-2,5	2,5	M4	8,0	12,0	5,0	4,5	2,3	0,8	1.000	0,106 \$
KSNKYN-5-2,5		M5	10,0	14,0	5,0	4,5	2,3	0,8	1.000	0,133 \$
KSNKYN-6-2,5		M6	11,0	16,0	5,0	4,5	2,3	0,8	1.000	0,159 \$
KSNKYN-8-2,5		M8	14,00	17,00	5,0	4,5	2,3	0,8	1.000	0,186 \$
KSNKYN-4-6	6	M4	8,0	14,0	6,0	6,0	3,6	1,0	1.000	0,212 \$
KSNKYN-5-6		M5	10,0	15,0	6,0	6,0	3,6	1,0	1.000	0,220 \$
KSNKYN-6-6		M6	11,0	16,0	6,0	6,0	3,6	1,0	1.000	0,212 \$
KSNKYN-8-6		M8	14,0	19,0	6,0	6,0	3,6	1,0	1.000	0,279 \$
KSNKYN-10-6		M10	18,0	21,0	6,0	6,0	3,6	1,0	500	0,332 \$
KSNKYN-5-10	10	M5	10,0	16,0	8,0	8,0	4,5	1,1	500	0,332 \$
KSNKYN-6-10		M6	11,0	17,0	8,0	8,0	4,5	1,1	500	0,345 \$
KSNKYN-8-10		M8	14,0	20,0	8,0	8,0	4,5	1,1	500	0,399 \$
KSNKYN-10-10		M10	18,0	21,0	8,0	8,0	4,5	1,1	500	0,465 \$
KSNKYN-5-16	16	M5	11,0	20,0	10,0	10,5	5,8	1,2	500	0,518 \$
KSNKYN-6-16		M6	11,0	20,0	10,0	10,5	5,8	1,2	500	0,532 \$
KSNKYN-8-16		M8	14,0	22,0	10,0	10,5	5,8	1,2	500	0,558 \$
KSNKYN-10-16		M10	18,0	24,0	10,0	10,5	5,8	1,2	500	0,638 \$
KSNKYN-12-16		M12	18,0	24,0	10,0	10,5	5,8	1,2	500	0,678 \$
KSNKYN-5-25	25	M5	12,0	25,0	11,0	12,0	7,5	1,5	250	0,798 \$
KSNKYN-6-25		M6	12,0	25,0	11,0	12,0	7,5	1,5	250	0,798 \$
KSNKYN-8-25		M8	16,0	25,0	11,0	12,0	7,5	1,5	200	0,798 \$
KSNKYN-10-25		M10	18,0	26,0	11,0	12,0	7,5	1,5	200	0,957 \$
KSNKYN-12-25		M12	18,0	26,0	11,0	12,0	7,5	1,5	200	0,957 \$
KSNKYN-6-35	35	M6	15,0	26,0	12,0	15,0	9,0	1,6	200	1,130 \$
KSNKYN-8-35		M8	16,0	26,0	12,0	15,0	9,0	1,6	200	1,276 \$
KSNKYN-10-35		M10	18,0	27,0	12,0	15,0	9,0	1,6	100	1,276 \$
KSNKYN-12-35		M12	18,0	27,0	12,0	15,0	9,0	1,6	100	1,276 \$

KSN® DIN 46234 TİP YUVARLAK (KAYNAKLI) KABLO PABUÇLARI

İTHALATIMIZ

Özellikler

- DIN 46234 e göre üretilmiştir
- Sıkma alanında sert lehimli
- Gelişmiş sıkma özellikleri için oluklu profil

Malzeme : Cu-ETP
Yüzey : Kalay kaplı

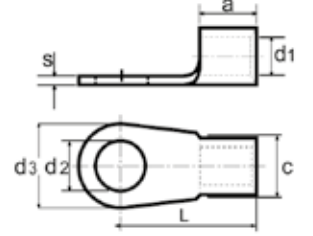

 RoHS
COMPLIANT

ÜRÜN KODU	Kablo Kesiti mm ²	Civata Ø	Boyutlar (mm)						Kutu Miktarı (Adet)	BİRİM FİYATI \$
			d3	L	a	c	d1	S		
KSNKYN-6-50	50	M6	18,0	34,0	16,0	17,0	11,0	1,8	100	2,074 \$
KSNKYN-8-50		M8	18,0	34,0	16,0	17,0	11,0	1,8	100	2,075 \$
KSNKYN-10-50		M10	18,0	34,0	16,0	17,0	11,0	1,8	100	2,075 \$
KSNKYN-12-50		M12	22,0	36,0	16,0	17,0	11,0	1,8	100	2,247 \$
KSNKYN-6-70	70	M6	22,0	38,0	18,0	21,0	13,0	2,0	50	2,793 \$
KSNKYN-8-70		M8	22,0	38,0	18,0	21,0	13,0	2,0	50	2,873 \$
KSNKYN-10-70		M10	22,0	38,0	18,0	21,0	13,0	2,0	50	3,032 \$
KSNKYN-12-70		M12	22,0	38,0	18,0	21,0	13,0	2,0	50	3,032 \$
KSNKYN-16-70		M16	22,0	38,0	18,0	21,0	13,0	2,0	50	3,032 \$
KSNKYN-6-95	95	M6	24,0	42,0	20,0	23,0	15,0	2,5	50	4,256 \$
KSNKYN-8-95		M8	24,0	42,0	20,0	23,0	15,0	2,5	50	4,335 \$
KSNKYN-10-95		M10	24,0	42,0	20,0	23,0	15,0	2,5	50	4,335 \$
KSNKYN-12-95		M12	24,0	42,0	20,0	23,0	15,0	2,5	50	4,335 \$
KSNKYN-16-95		M16	24,0	42,0	20,0	23,0	15,0	2,5	50	4,482 \$
KSNKYN-8-120	120	M8	24,0	44,0	22,0	24,0	16,5	3,0	25	5,985 \$
KSNKYN-10-120		M10	24,0	44,0	22,0	24,0	16,5	3,0	25	5,985 \$
KSNKYN-12-120		M12	24,0	44,0	22,0	24,0	16,5	3,0	25	5,985 \$
KSNKYN-16-120		M16	24,0	44,0	22,0	24,0	16,5	3,0	25	6,720 \$
KSNKYN-10-150	150	M10	30,0	50,0	24,0	28,0	19,0	3,2	20	10,310 \$
KSNKYN-12-150		M12	30,0	50,0	24,0	28,0	19,0	3,2	20	10,310 \$
KSNKYN-16-150		M16	30,0	50,0	24,0	28,0	19,0	3,2	20	10,310 \$
KSNKYN-10-185	185	M10	36,0	50,0	28,0	33,0	21,0	3,5	20	13,960 \$
KSNKYN-12-185		M12	36,0	50,0	28,0	33,0	21,0	3,5	20	13,960 \$
KSNKYN-16-185		M16	36,0	50,0	28,0	33,0	21,0	3,5	20	13,960 \$
KSNKYN-10-240	240	M10	36,0	50,0	28,0	33,0	21,0	3,5	20	18,900 \$
KSNKYN-12-240		M12	36,0	50,0	28,0	33,0	21,0	3,5	20	18,900 \$
KSNKYN-16-240		M16	36,0	50,0	28,0	33,0	21,0	3,5	20	18,100 \$



www.konsangroup.com

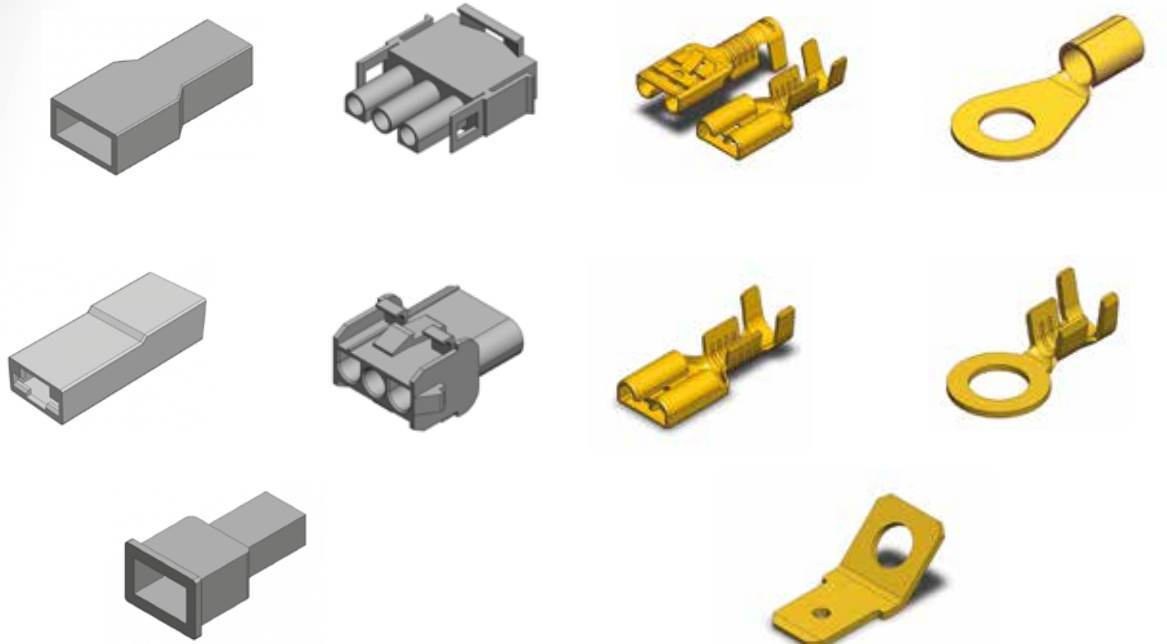









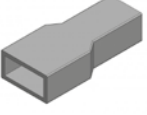
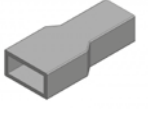
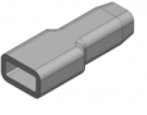
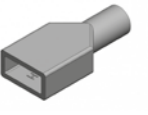



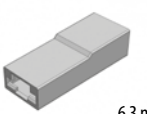
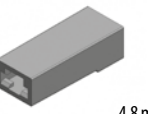
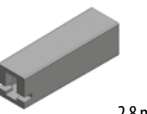
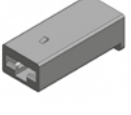
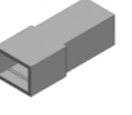
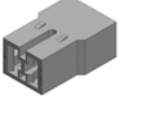

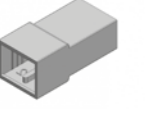
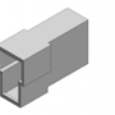
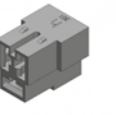
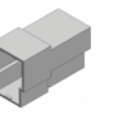
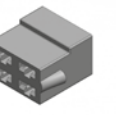
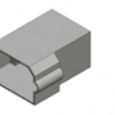
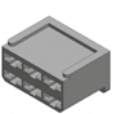

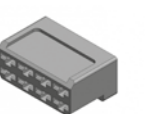
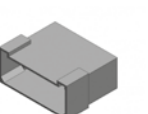

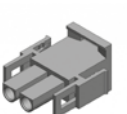
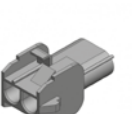
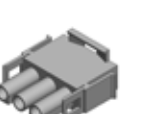

İZOLESİZ KABLO UÇLARI VE KONNEKTÖRLERİ



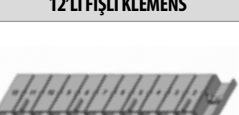

SF-1D  6,3 mm	SF-2D  6,3 mm	SF-1D MİNİ  4,8 mm	SF-1/2D  2,8 mm	SF-3D 	SF-1D EĞRİ 	SF-1D MİNİ EĞRİ 	SF-1DE  6,3 mm
SF-1DE MİNİ  4,8 mm	KRİMP 	SF-1D MİNİ TIRNAKLI  4,8 mm	SF-21D KİLİTLİ  6,3 mm	SF-23DKM KİLİTLİ  6,3 mm	SF-1EÇK 	SF-1EU1 	SF-12EU  2,8 mm
SK-2,5-04 	SK-4-04 	SK-6-06 	SW-4-04 	SW-5-05 	SKN-1-04 	SKN-2,5-04 	SKN-4-05 
SKN-6-06 	SKN-6-08 	SKN-10-08 	SKN-10-10 	SKN-10-12 	AVİZE TERMİNALİ 	SKN-1C 	SKN-2,5C 
SKN-4C 	SKN-6C 	SKF-8 	SF-4D 	SF-4E 	SWB BUJİ 	SF-22D 	SF-22E 
SFK-1-03  6,3 mm	SFK-1-03-45°  6,3 mm	SFK-1-03-90°  6,3 mm	SFK-1-04  6,3 mm	SFK-1-04-45°  6,3 mm	SFK-1-04-90°  6,3 mm	SFK-1-04-T  6,3 mm	SFK-1-05  6,3 mm
SFK-1-05-45°  6,3 mm	SFK-1-05-90°  6,3 mm	SFK-14  6,3 mm	SFK-25  6,3 mm	SFK-25 MİNİ  4,8 mm	SFK-35  6,3 mm	SFK-39  6,3 mm	SFK-43  6,3 mm
SFK-55  6,3 mm	BA-10 	BA-16 	BA-25 	BA-35 	BA-50 	BA-70 	BK-70 



SF-1D KILIF 	SF-1D KILIF PVC 	SF-1D MİNİ KILIF 	SF-3D KILIF 	SF-1E KILIF 
SF-1D EĞRİ PVC KILIF 	SF-1D EĞRİ KONNEKTÖR  6,3 mm	R2 TİPİ KONNEKTÖR  6,3 mm	R TİPİ KONNEKTÖR  4,8 mm	R TİPİ KONNEKTÖR  2,8 mm
101 ERKEK KONNEKTÖR 	101 DIŞI KONNEKTÖR 	201 ERKEK KONNEKTÖR 	201-T ERKEK KONNEKTÖR 	202 DIŞI KONNEKTÖR 
202-T DIŞI KONNEKTÖR 	301 ERKEK KONNEKTÖR 	302 DIŞI KONNEKTÖR 	401 ERKEK KONNEKTÖR 	402 DIŞI KONNEKTÖR 
601 ERKEK KONNEKTÖR 	602 ERKEK KONNEKTÖR 	801 ERKEK KONNEKTÖR 	802 DIŞI KONNEKTÖR 	SF-21D DIŞI KONNEKTÖR 
SF-22E 2'Lİ ERKEK KONNEKTÖR 	SF-22D 2'Lİ DIŞI KONNEKTÖR 	SF-22E 3'LÜ ERKEK KONNEKTÖR 	SF-22D 3'LÜ DIŞI KONNEKTÖR 	SF-22E 4'LÜ ERKEK KONNEKTÖR 
SF-22D 4'LÜ DIŞI KONNEKTÖR 	SF-22E 6'Lİ ERKEK KONNEKTÖR 	SF-22D 6'Lİ DIŞI KONNEKTÖR 	SF-22E 9'LU ERKEK KONNEKTÖR 	SF-22D 9'LU DIŞI KONNEKTÖR 
12'Lİ FİŞLİ KLEMENS 	4,8 PVC KILIF 	6,3 PVC KILIF 	4,8 EĞRİ PVC KILIF 	6,3 EĞRİ PVC KILIF 

ÜRÜN KODU	CİNSİ		AD. / ₺
HF-1D	Dişi Terminal	6,3 mm	1,800 ₺
HF-2D	Tırnaklı Diş Terminal	6,3 mm	1,630 ₺
HF-1D	Mini Dişi Terminal	4,8 mm	1,370 ₺
HF-½ D	Mikro Dişi Terminal	2,8 mm	1,070 ₺
HF-3D	Dişi Terminal		5,050 ₺
HF-1D	Eğri Dişi Terminal	6,3 mm	2,600 ₺
HF-1D	Mini Eğri Dişi Terminal	4,8 mm	2,300 ₺
HF-1DE	Dişi + Erkek Terminal	6,3 mm	4,540 ₺
HF-1D	DÇN Dişi Terminal	6,3 mm	1,450 ₺
HF-1E ÇK	Erkek Terminal	6,3 mm	1,950 ₺
HF-1EU1	Uzun Erkek Terminal	6,3 mm	2,000 ₺
HF-1E	Mini Erkek Terminal	4,8 mm	1,900 ₺
HF-½	Mikro Erkek Terminal	2,8 mm	1,900 ₺
HSK-2,5	Boru Tip Topraklama Terminali		1,370 ₺
HSK-4	Boru Tip Topraklama Terminali		2,430 ₺
HSK-6	Boru Tip Topraklama Terminali		2,520 ₺
HSW-4	Topraklama Terminali		1,170 ₺
HSKN-1	Topraklama Terminali		1,800 ₺
HSKN-2,5	Topraklama Terminali		1,820 ₺
HSKN-4	Topraklama Terminali		3,200 ₺
HSKN-6	Topraklama Terminali		4,850 ₺
HSKN-10	Topraklama Terminali		6,200 ₺
HSB-W	Buji Terminali TYD-2607		4,950 ₺
HSKN-1 C	Çatal Terminal		1,800 ₺
HSKN-2,5 C	Çatal Terminal		1,820 ₺
HSKN-4 C	Çatal Terminal		3,200 ₺
HSKN-6 C	Çatal Terminal		4,850 ₺
HSF-1D DPK	Kalaylı	6,3 mm	2,750 ₺
HSF-2D DPK	Kalaylı Tırnaklı	6,3 mm	2,550 ₺
HSF-1D B	Büyük ayak		2,290 ₺
HSF-1D K	Küçük ayak		1,800 ₺
TE-2346	SFK-8		4,950 ₺

ÜRÜN KODU	CİNSİ		AD. / ₺
HF-1D	Kılıf	6,3 mm	0,600 ₺
HF-1D	Renkli Kılıf	6,3 mm	0,650 ₺
HF-1D	Mini Kılıf	4,8 mm	0,600 ₺
HF-1E	Erkek Kılıf	6,3 mm	1,560 ₺
HF-3D	Kılıf	9,5 mm	1,800 ₺
R Tipi	Konnektör	6,3 mm	1,050 ₺
R Tipi	Konnektör	4,8 mm	1,175 ₺
R Tipi	Konnektör	2,8 mm	0,936 ₺
HF-1D	Eğri Konnektör	6,3 mm	2,400 ₺
BYT - 10	Bakır Top.Kablo Ucu		16,900 ₺
BYT - 16	Bakır Top.Kablo Ucu		24,000 ₺
BYT - 25	Bakır Top.Kablo Ucu		32,500 ₺
BYT - 35	Bakır Top.Kablo Ucu		51,500 ₺
BYT - 50	Bakır Top.Kablo Ucu		86,200 ₺
BYT - 70	Bakır Top.Kablo Ucu		146,500 ₺
41100	Telefon.Çatal Terminal		1,150 ₺
Mikro	Telefon Dişi Fiş 2,8 mm		1,170 ₺
TÖZ-2031	Kart Tipi DPK Dişi Terminal	6,3 mm	3,250 ₺
TD-2162	DPK Kart Tipi Dişi Terminal	6,3 mm	4,500 ₺
HSFK-25	Kart Tipi Erkek Terminal	6,3 mm	2,750 ₺
HSFK-35	Kart Tipi Erkek Terminal	6,3 mm	2,530 ₺
HSFK-39	Kart Tipi Erkek Terminal	6,3 mm	2,530 ₺
HSFK-43	Kart Tipi Erkek Terminal	6,3 mm	2,530 ₺
SFK-1-04	Toprak. Terminali TE-2339		3,080 ₺
HF-1D	DPG Dişi Terminal	6,3 mm	5,370 ₺
HF-2D	DPG Dişi Terminal	6,3 mm	5,370 ₺
HF-1EU1	DPG Uzun Erkek		6,720 ₺
TD-2160	DPK Kilitli Dişi Terminal	6,3 mm	7,800 ₺
TYD-2606	HF-4D Yuvarlak Dişi Term.		2,870 ₺
TYD-2704	HF-4E Yuvarlak Erkek Term.		2,880 ₺
	Kutup Başı Kılıfı		42,000 ₺

KYD-3801 / KYE-3901	1'Lİ DİŞİ ve ERKEK KONNEKTÖR	5,450 / AD. / ₺	10,900 / TK. / ₺
KYD-3802 / KYE-3902	2'Lİ DİŞİ ve ERKEK KONNEKTÖR	7,900 / AD. / ₺	15,800 / TK. / ₺
KYD-3803 / KYE- 3903	3'LÜ DİŞİ ve ERKEK KONNEKTÖR	9,300 / AD. / ₺	18,600 / TK. / ₺
KYD-3804 / KYE-3904	4'LÜ DİŞİ ve ERKEK KONNEKTÖR	12,800 / AD. / ₺	25,600 / TK. / ₺
KYD-3805 / KYE-3905	6'LI DİŞİ ve ERKEK KONNEKTÖR	14,000 / AD. / ₺	28,000 / TK. / ₺
KYD-3806 / KYE-3906	9'LU DİŞİ ve ERKEK KONNEKTÖR	21,000 / AD. / ₺	42,000 / TK. / ₺
KYD-3807 / KYE-3907	12'Lİ DİŞİ ve ERKEK KONNEKTÖR	27,500 / AD. / ₺	55,000 / TK. / ₺
KYD-3808 / KYE-3908	15'Lİ DİŞİ ve ERKEK KONNEKTÖR	30,300 / AD. / ₺	60,600 / TK. / ₺
TYE-2705 / SF-22 E	ERKEK TERMİNAL		3,700 ₺
TYD-2614 / SF-22 D	DİŞİ TERMİNAL		3,700 ₺



www.konsangroup.com

Ø22 BUTON GRUBU & LED SİNYALLER



KSN® Ø22 YAYLI BUTONLAR

İTHALATIMIZ



Sipariş Kodu	Ürün Kodu	Açıklama	Kontakt	Renk	Kutu Adedi	Birim Fiyatı (₺)
	KN-55-10	Start Yaylı Buton	1NO	Yeşil	10	120,00 ₺
	KN-55-01	Stop Yaylı Buton	1NC	Kırmızı	10	120,00 ₺
	KN-55-11	Start Yaylı Buton	1NO	Sarı	10	120,00 ₺
	KN-55-21	Start Yaylı Buton	1NO	Mavi	10	120,00 ₺
	KN-55-31	Start Yaylı Buton	1NO	Beyaz	10	120,00 ₺
	KN-55-41	Start Yaylı Buton	1NO	Siyah	10	120,00 ₺

KSN® Ø22 IŞIKLI YAYLI BUTONLAR

İTHALATIMIZ





Sipariş Kodu	Ürün Kodu	Açıklama	Kontakt	Renk	Kutu Adedi	Birim Fiyatı (₺)
	KN-55-10D	Işıkli Yaylı Buton 220V AC/DC	1NO	Yeşil	10	215,00 ₺
	KN-55-01D		1NC	Kırmızı	10	215,00 ₺
	KN-55-11D		1NO	Sarı	10	215,00 ₺
	KN-55-21D		1NO	Mavi	10	215,00 ₺
	KN-55-31D		1NO	Beyaz	10	215,00 ₺
	KN-55-10D-110	Işıkli Yaylı Buton 110V AC/DC	1NO	Yeşil	10	215,00 ₺
	KN-55-01D-110		1NC	Kırmızı	10	215,00 ₺
	KN-55-11D-110		1NO	Sarı	10	215,00 ₺
	KN-55-21D-110		1NO	Mavi	10	215,00 ₺
	KN-55-31D-110		1NO	Beyaz	10	215,00 ₺
	KN-55-10D-24	Işıkli Yaylı Buton 24V AC/DC	1NO	Yeşil	10	215,00 ₺
	KN-55-01D-24		1NC	Kırmızı	10	215,00 ₺
	KN-55-11D-24		1NO	Sarı	10	215,00 ₺
	KN-55-21D-24		1NO	Mavi	10	215,00 ₺
	KN-55-31D-24		1NO	Beyaz	10	215,00 ₺





KSN® Ø22 KALICI MANDAL BUTONLAR

İTHALATIMIZ

Sipariş Kodu	Ürün Kodu	Açıklama	Kontak	Kutu Adedi	Birim Fiyatı (₺)
	KN-55-10X	0-1 Mandal Buton 	1NO	10	140,00 ₺
	KN-55-20XS	1-0-2 Mandal Buton 	2NO	10	185,00 ₺



KSN® Ø22 KAYICI MANDAL BUTONLAR

İTHALATIMIZ

Sipariş Kodu	Ürün Kodu	Açıklama	Kontak	Kutu Adedi	Birim Fiyatı (₺)
	KN-55-10X/FU	0-1 Mandal Buton 	1NO	10	155,00 ₺
	KN-55-20XS/FU	1-0-2 Mandal Buton 	2NO	10	200,00 ₺

KSN® Ø22 ANAHTARLI KALICI BUTONLAR







İTHALATIMIZ

Sipariş Kodu	Ürün Kodu	Açıklama	Kontak	Kutu Adedi	Birim Fiyatı (₺)
	KN-55-10Y	0-1 Anahtarlı Buton 	1NO	10	200,00 ₺
	KN-55-20YS	1-0-2 Anahtarlı Buton 	2NO	10	250,00 ₺

KSN® Ø22 IŞIKLI KALICI MANDAL BUTONLAR

İTHALATIMIZ



Sipariş Kodu	Ürün Kodu	Açıklama	Kontakt	Renk	Kutu Adedi	Birim Fiyatı (₺)
	KN-55-10XD	 0-1 Işıklı Mandal Buton 220V AC/DC	1NO	Yeşil	10	220,00 ₺
	KN-55-01XD		1NC	Kırmızı	10	220,00 ₺
	KN-55-11XD		1NO	Sarı	10	220,00 ₺
	KN-55-10XD-110	 0-1 Işıklı Mandal Buton 110V AC/DC	1NO	Yeşil	10	220,00 ₺
	KN-55-01XD-110		1NC	Kırmızı	10	220,00 ₺
	KN-55-11XD-110		1NO	Sarı	10	220,00 ₺
	KN-55-10XD-24	 0-1 Işıklı Mandal Buton 24V AC/DC	1NO	Yeşil	10	220,00 ₺
	KN-55-01XD-24		1NC	Kırmızı	10	220,00 ₺
	KN-55-11XD-24		1NO	Sarı	10	220,00 ₺
	KN-55-20XSD	 1-0-2 Işıklı Mandal Buton 220V AC/DC	2NO	Yeşil	10	265,00 ₺
	KN-55-02XSD		2NC	Kırmızı	10	265,00 ₺
	KN-55-21XSD		2NO	Sarı	10	265,00 ₺
	KN-55-20XSD-110	 1-0-2 Işıklı Mandal Buton 110V AC/DC	2NO	Yeşil	10	265,00 ₺
	KN-55-02XSD-110		2NC	Kırmızı	10	265,00 ₺
	KN-55-21XSD-110		2NO	Sarı	10	265,00 ₺
	KN-55-20XSD-24	 1-0-2 Işıklı Mandal Buton 24V AC/DC	2NO	Yeşil	10	265,00 ₺
	KN-55-02XSD-24		2NC	Kırmızı	10	265,00 ₺
	KN-55-21XSD-24		2NO	Sarı	10	265,00 ₺

KSN® YARDIMCI KONTAKLAR

İTHALATIMIZ



Sipariş Kodu	Ürün Kodu	Açıklama	Kontakt	Kutu Adedi	Birim Fiyatı (₺)
	KSN-LA-101	Start Kontakt	1NO	10	49,00 ₺
	KSN-LA-102	Stop Kontakt	1NC	10	49,00 ₺

KSN® Ø22 KALICI MANTAR BUTON (40mm)

İTHALATIMIZ



Sipariş Kodu	Ürün Kodu	Açıklama	Kontak	Renk	Kutu Adedi	Birim Fiyatı (₺)
	KN-55-01ZS	Stop Mantar Buton	1NC	 Kırmızı	10	155,00 ₺

KSN® Ø22 KALICI ANAHTARLI MANTAR BUTON (40mm)

İTHALATIMIZ



Sipariş Kodu	Ürün Kodu	Açıklama	Kontak	Renk	Kutu Adedi	Birim Fiyatı (₺)
	KN-BZ-01ZA	Anahtarlı Stop Mantar Buton	1NC	 Kırmızı	10	230,00 ₺

KSN® Ø22 KAYICI MANTAR BUTON (40mm)

İTHALATIMIZ





Sipariş Kodu	Ürün Kodu	Açıklama	Kontak	Renk	Kutu Adedi	Birim Fiyatı (₺)
	KN-55-01M	Stop Mantar Buton	1NC	 Kırmızı	10	140,00 ₺

KSN® Ø22 İKİZ BUTON

İTHALATIMIZ



Sipariş Kodu	Ürün Kodu	Açıklama	Kontak	Renk	Kutu Adedi	Birim Fiyatı (₺)
	KN-55-11R	İkiz Buton	1NO+1NC	 Yeşil - Kırmızı	10	220,00 ₺
	KN-55-11RD	Işıklı İkiz Buton 220V AC/DC	1NO+1NC	 Yeşil - Kırmızı	10	310,00 ₺
	KN-55-11RD-24	Işıklı İkiz Buton 24V AC/DC	1NO+1NC	 Yeşil - Kırmızı	10	310,00 ₺

KSN® Ø22 mm LED SİNYALLER

İTHALATIMIZ



Sipariş Kodu	Ürün Kodu	Açıklama	Renk	Kutu Adedi	Birim Fiyatı (₺)
	KSN-22-K	Led Sinyal 220V AC/DC	● Kırmızı	10	47,00 ₺
	KSN-22-Y		● Yeşil	10	47,00 ₺
	KSN-22-S		● Sarı	10	47,00 ₺
	KSN-22-M		● Mavi	10	47,00 ₺
	KSN-22-B		○ Beyaz	10	50,00 ₺
	KSN-22-110V-K	Led Sinyal 110V AC/DC	● Kırmızı	10	47,00 ₺
	KSN-22-110V-Y		● Yeşil	10	47,00 ₺
	KSN-22-110V-S		● Sarı	10	47,00 ₺
	KSN-22-110V-M		● Mavi	10	47,00 ₺
	KSN-22-110V-B		○ Beyaz	10	50,00 ₺
	KSN-22-24V-K	Led Sinyal 24V AC/DC	● Kırmızı	10	47,00 ₺
	KSN-22-24V-Y		● Yeşil	10	47,00 ₺
	KSN-22-24V-S		● Sarı	10	47,00 ₺
	KSN-22-24V-M		● Mavi	10	47,00 ₺
	KSN-22-24V-B		○ Beyaz	10	50,00 ₺

KSN® Ø22 mm LED'Lİ BUZZER (90 dB)

İTHALATIMIZ





Sipariş Kodu	Ürün Kodu	Açıklama	Renk	Kutu Adedi	Birim Fiyatı (₺)
	KSN-22DS/MS	Sesli Led Flaşör İkazlı 220V AC/DC	● Kırmızı	10	180,00 ₺
	KSN-22DS/MS24	Sesli Led Flaşör İkazlı 24V AC/DC	● Kırmızı	10	180,00 ₺

KSN® Ø22 mm VOLTMETRE

İTHALATIMIZ



Sipariş Kodu	Ürün Kodu	Açıklama	Renk	Kutu Adedi	Birim Fiyatı (₺)
	KSN-22-V-K	Ø 22 mm Led 24-450V Voltmetre	 Kırmızı	10	168,00 ₺
	KSN-22-V-Y		 Yeşil	10	168,00 ₺
	KSN-22-V-S		 Sarı	10	168,00 ₺
	KSN-22-V-M		 Mavi	10	168,00 ₺
	KSN-22-V-B		 Beyaz	10	168,00 ₺

KSN® Ø22 mm AMPERMETRE

İTHALATIMIZ



Sipariş Kodu	Ürün Kodu	Açıklama	Renk	Kutu Adedi	Birim Fiyatı (₺)
	KSN-22-A-K	Ø 22 mm Led 100A Ampemetre	 Kırmızı	5	330,00 ₺
	KSN-22-A-Y		 Yeşil	5	330,00 ₺
	KSN-22-A-S		 Sarı	5	330,00 ₺
	KSN-22-A-M		 Mavi	5	330,00 ₺
	KSN-22-A-B		 Beyaz	5	330,00 ₺

KSN® Ø 22 mm POTANSİYOMETRE

İTHALATIMIZ



Sipariş Kodu	Ürün Kodu	VOLTAJ	Açıklama	Kutu Adedi	Birim Fiyatı (₺)
	KSN22-5K	220V	5K Potansiyometre Tek Tur	10	230,00 ₺
	KSN22-10K	220V	10K Potansiyometre Tek Tur	10	230,00 ₺

KSN® MOTORLU SİREN

İTHALATIMIZ

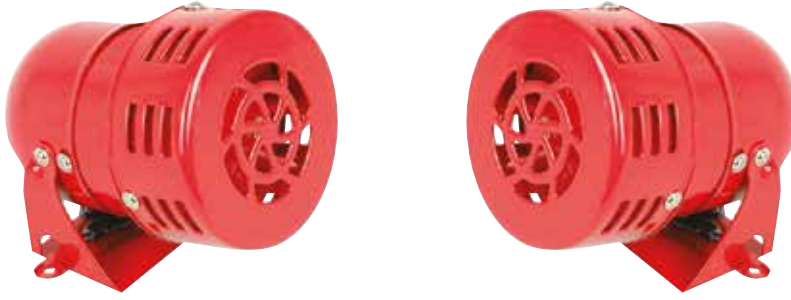

Sipariş Kodu	Ürün Kodu	Açıklama	Kutu Adedi	Birim Fiyatı (₺)
	MS-190-220V	Ø 75 mm Metal Gövde 220 V AC Siren	10	730,00 ₺
	MS-190-24V	Ø 75 mm Metal Gövde 24 V AC Siren	10	730,00 ₺

KÖPRÜ DİYOT



ÜRÜN KODU	cinsi	AD. / \$
KBPC 3510	35A 1000 V Köprü Diyot	1,00 \$
KBPC 5010	50A 1000 V Köprü Diyot	1,25 \$

ST SERİSİ TERMİK SİGORTA



- 3A • 16A
- 5A • 20A
- 8A • 25A
- 10A • 30A
- 12A • 40A
- 15A • 50A

ÜRÜN KODU	AKIM	cinsi	AD. / \$
HWA-271S	3A - 20A	125/250VAC 32 VDC	0,80 \$
	25A		0,90 \$
	30A		1,00 \$
	40A		2,20 \$
	50A		2,20 \$

KSN® ACIL STOP MANTAR BUTON KUTULU

İTHALATIMIZ







Sipariş Kodu	Ürün Kodu	Renk	Kontakt	Açıklama	Kutu Adedi	Birim Fiyat TL
		Sarı/Siyah	1NC	Acil Stop Mantar Buton Kutulu	100	210,00 ₺

KSN® BOŞ KUMANDA KUTULARI

İTHALATIMIZ



Sipariş Kodu	Ürün Kodu	Renk	Açıklama	Kutu Adedi	Birim Fiyat TL
		Sarı/Siyah	1'li Boş Kumanda Kutusu	100	80,00 ₺
		Sarı/Siyah	2'li Boş Kumanda Kutusu	100	100,00 ₺
		Sarı/Siyah	3'lü Boş Kumanda Kutusu	100	130,00 ₺
		Sarı/Siyah	4'lü Boş Kumanda Kutusu	50	165,00 ₺
		Sarı/Siyah	5'li Boş Kumanda Kutusu	50	240,00 ₺
		Sarı/Siyah	6'lı Boş Kumanda Kutusu	50	240,00 ₺

Sipariş Kodu	Ürün Kodu	Açıklama	Kutu Adedi	Birim Fiyat TL
		 22 mm Buton Rozeti (25 x h:22mm Etiket Ölçü)	100	6,60 ₺
		 60 mm Acil Stop Etiketi	200	17,00 ₺
		 Acil Stop Buton Koruma Kapağı	16	110,00 ₺
		 22 mm Buton Koruma Kapağı	16	90,00 ₺
		 22 mm Buton Koruma Kılıfı	200	14,00 ₺



www.konsangroup.com

DAĞITICI ÜNİTELER & KOMPAKT ÇOK AMAÇLI KLEMENSLER

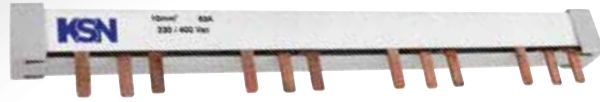

KSN® 2 KUTUPLU DAĞITICI ÜNİTELER
İTHALATIMIZ

Ürün Kodu	KSN-DU-2x7	
Sipariş Kodu		
Akım	125 A	
Kablo Cinsi	Tek Damar	Çok Telli
Kablo Kesit (mm ²)	Giriş	Çıkış
	1x10-35 mm ²	1x10-25 mm ² 5x2,5-6 mm ²
	1x10-16 mm ²	1x6-16 mm ² 5x1,5-6 mm ²
Ambalaj	Paket	Koli
	1	100

L: 65 W:42 H:50 mm



Fiyatı (₺)

370,00 ₺

Ürün Kodu	KSN-DU-2x11	
Sipariş Kodu		
Akım	125 A	
Kablo Cinsi	Tek Damar	Çok Telli
Kablo Kesit (mm ²)	Giriş	Çıkış
	2x10-35 mm ²	2x10-25 mm ² 7x2,5-6 mm ²
	2x10-16 mm ²	2x6-16 mm ² 7x1,5-6 mm ²
Ambalaj	Paket	Koli
	1	100

L: 100 W:42 H:50 mm

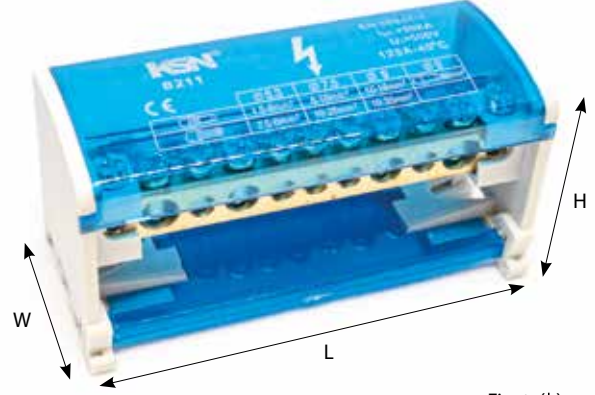

Fiyatı (₺)

530,00 ₺

Ürün Kodu	KSN-DU-2x15	
Sipariş Kodu		
Akım	125 A	
Kablo Cinsi	Tek Damar	Çok Telli
Kablo Kesit (mm ²)	Giriş	Çıkış
	2x10-35 mm ²	2x10-25 mm ² 11x2,5-6 mm ²
	2x10-16 mm ²	2x6-16 mm ² 11x1,5-6 mm ²
Ambalaj	Paket	Koli
	1	100

L: 135 W:42 H:50 mm

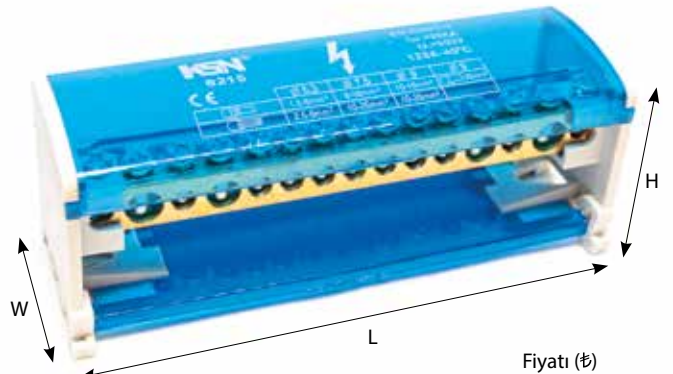

Fiyatı (₺)

680,00 ₺

KSN® 4 KUTUPLU DAĞITICI ÜNİTELER

İTHALATIMIZ

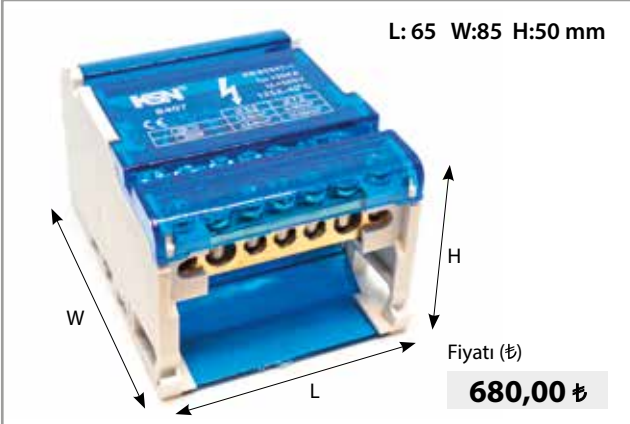

Ürün Kodu	KSN-DU-4x7	
Sipariş Kodu		
Akım	125 A	
Kablo Cinsi	Tek Damar	Çok Telli
Kablo Kesit (mm ²)	Giriş	Çıkış
	1x10-35 mm ²	1x10-25 mm ² 5x2,5-6 mm ²
	1x10-16 mm ²	1x6-16 mm ² 5x1,5-6 mm ²
Ambalaj	Paket	Koli
	1	100

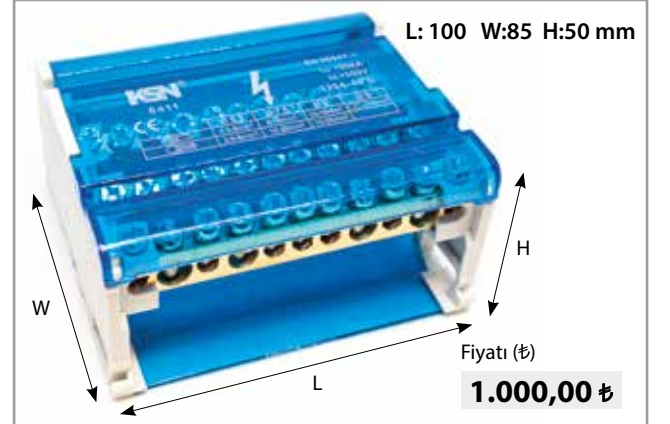

Ürün Kodu	KSN-DU-4x11	
Sipariş Kodu		
Akım	125 A	
Kablo Cinsi	Tek Damar	Çok Telli
Kablo Kesit (mm ²)	Giriş	Çıkış
	2x10-35 mm ²	2x10-25 mm ² 7x2,5-6 mm ²
	2x10-16 mm ²	2x6-16 mm ² 7x1,5-6 mm ²
Ambalaj	Paket	Koli
	1	50

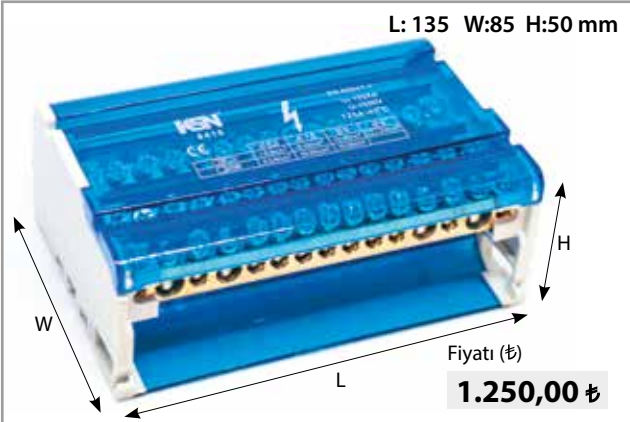

Ürün Kodu	KSN-DU-4x15	
Sipariş Kodu		
Akım	125 A	
Kablo Cinsi	Tek Damar	Çok Telli
Kablo Kesit (mm ²)	Giriş	Çıkış
	2x10-35 mm ²	2x10-25 mm ² 11x2,5-6 mm ²
	2x10-16 mm ²	2x6-16 mm ² 11x1,5-6 mm ²
Ambalaj	Paket	Koli
	1	50

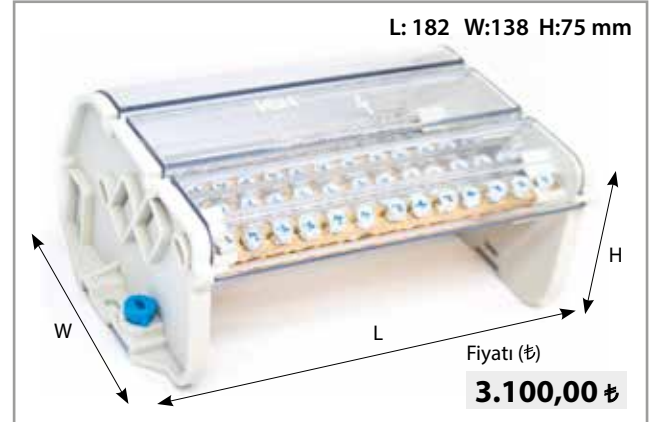

Ürün Kodu	KSN-DU-4x13/160A	
Sipariş Kodu		
Akım	160 A	
Kablo Cinsi	Tek Damar	Çok Telli
Kablo Kesit (mm ²)	Giriş	Çıkış
	1x10-50 mm ²	3x10-35 mm ² 8x2,5-16 mm ²
	1x10-50 mm ²	3x6-25 mm ² 8x1,5-16 mm ²
Ambalaj	Paket	Koli
	1	20

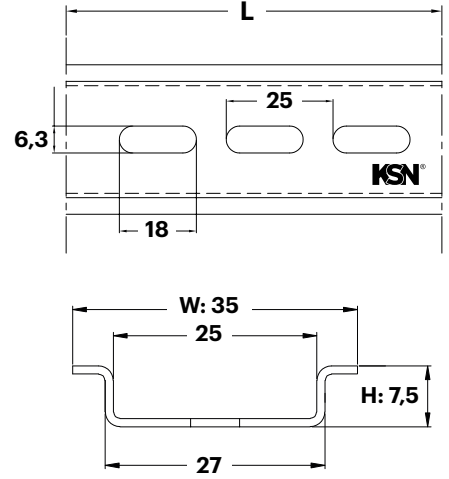
KSN® DELİKLİ W OTOMAT RAYI
İMALATIMIZ

ÜRÜN KODU	ÖLÇÜ (L)	AÇIKLAMA	Kutu Miktarı (Adet)	BİRİM FİYATI ₺
KSNRAY-001	30 cm	Delikli / Deliksiz W Otomat Rayı	150	22,00 ₺
KSNRAY-002	1 m	Delikli / Deliksiz W Otomat Rayı	50	60,00 ₺
KSNRAY-003	2 m	Delikli / Deliksiz W Otomat Rayı	50	120,00 ₺

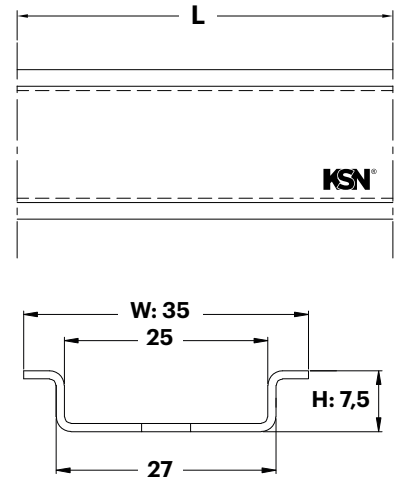
KSN® W OTOMAT RAYI
İMALATIMIZ

ÜRÜN KODU	ÖLÇÜ (L)	AÇIKLAMA	Kutu Miktarı (Adet)	BİRİM FİYATI ₺
KSNRAY-001	30 cm	Delikli / Deliksiz W Otomat Rayı	150	22,00 ₺
KSNRAY-002	1 m	Delikli / Deliksiz W Otomat Rayı	50	60,00 ₺
KSNRAY-003	2 m	Delikli / Deliksiz W Otomat Rayı	50	120,00 ₺

KSN® TRİFAZE MÜŞTEREK W OTOMAT BARALARI

İMALATIMIZ

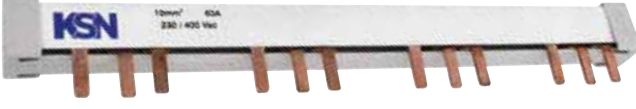

ÜRÜN KODU	ÖLÇÜ	BAKIR KALINLIĞI	AKIM (A)	MODÜL	Kutu Miktarı (Adet)	BİRİM FİYATI ₺
KSNBR-013	53 cm	0,8 mm	63A	10	25	750,00 ₺
KSNBR-014	106 cm	0,8 mm	63A	20	25	1.500,00 ₺
KSNBR-001	53 cm	1 mm	80A	10	25	900,00 ₺
KSNBR-002	106 cm	1 mm	80A	20	25	1.800,00 ₺
KSNBR-003	53 cm	1,5 mm	100A	10	25	1.350,00 ₺
KSNBR-004	106 cm	1,5 mm	100A	20	25	2.700,00 ₺

KSN® MONOFAZE MÜŞTEREK W OTOMAT BARALARI

İMALATIMIZ



ÜRÜN KODU	ÖLÇÜ	BAKIR KALINLIĞI	AKIM (A)	MODÜL	Kutu Miktarı (Adet)	BİRİM FİYATI ₺
KSNBR-015	53 cm	0,8 mm	63A	10	25	240,00 ₺
KSNBR-016	106 cm	0,8 mm	63A	20	25	480,00 ₺
KSNBR-009	53 cm	1 mm	80A	30	50	300,00 ₺
KSNBR-010	106 cm	1 mm	80A	60	50	600,00 ₺
KSNBR-011	53 cm	1,5 mm	100A	30	50	450,00 ₺
KSNBR-012	106 cm	1,5 mm	100A	60	50	900,00 ₺

KSN® NÖTR VİDALI TOPRAKLAMA BARALARI

İMALATIMIZ



ÜRÜN KODU	MODÜL	BAKIR KALINLIĞI	Kutu Miktarı (Adet)	BİRİM FİYATI ₺
KSNBR-005	31 Vida	1,5 x 15,0	20	
KSNBR-006	61 Vida	1,5 x 15,0	20	
KSNBR-007	31 Vida	2,0 x 15,0	20	
KSNBR-008	61 Vida	2,0 x 15,0	20	

KSN® PANO İÇİ TERMOSTATLAR

İTHALATIMIZ

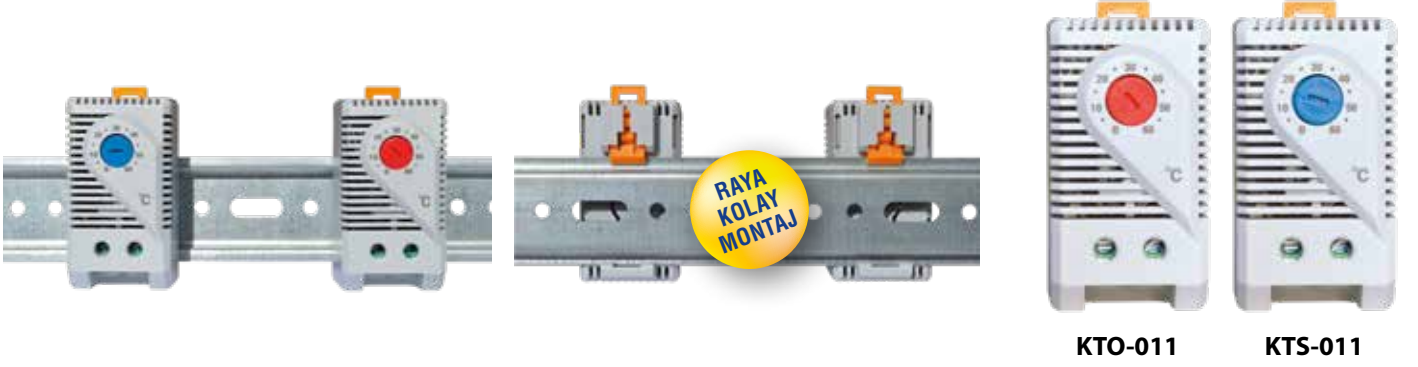

ÜRÜN KODU	AÇIKLAMA	KONTAK TİPİ	ÇALIŞMA ÖMRÜ (Açma-Kapama)	ÖLÇÜLER (mm)	KUTU MİKTARI (ADET)	BİRİM FİYATI (\$)
KTO-011	Isıtma Termostatı (0-60 °C)	Kapalı	100.000	60 x 33 x 43	10	6,00 \$
KTS-011	Soğutma Termostatı (0-60 °C)	Açık	100.000	60 x 33 x 43	10	6,00 \$

KSN® UNIVERSAL SAYICILAR

İTHALATIMIZ

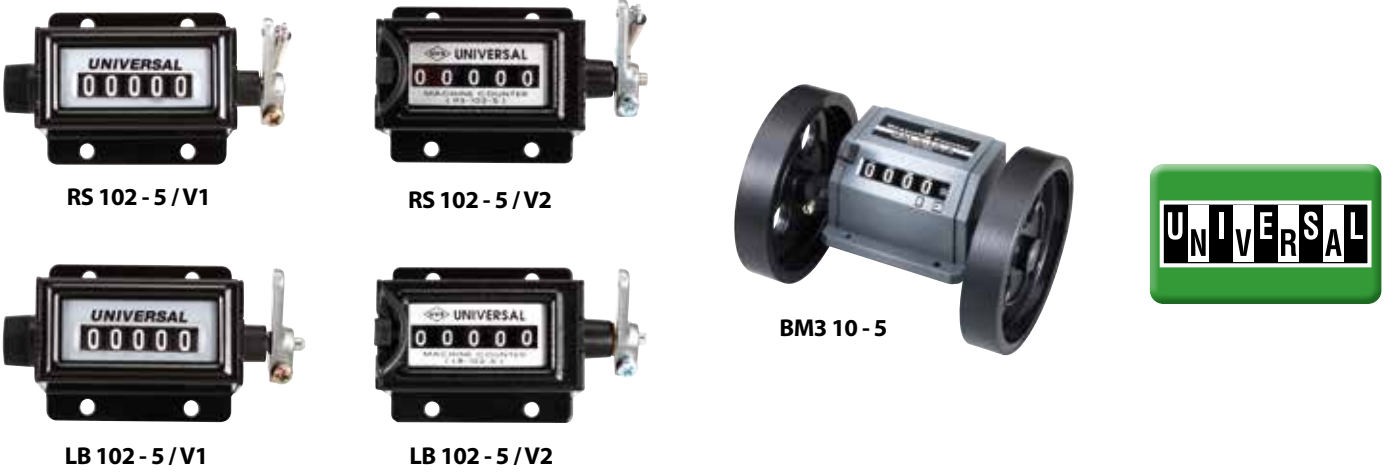

ÜRÜN KODU	AÇIKLAMA	Sıfırlama	Dijital Hane Sayısı	Rakam Ölçüsü (mm)	Montaj Boyutu (mm)	Maks. Hesaplama Hızı	BİRİM FİYATI (\$)
RS 102 - 5 V1	Darbeli Turmetre	Çevirerek	5	3,5 x 5	37 x 30 x Ø 4,1	600 / Devir	7,50 \$
RS 102 - 5 V2	Darbeli Turmetre	Basmalı	5	3,5 x 5	37 x 30 x Ø 4,1	600 / Devir	11,50 \$
LB 102 - 5 V1	Dönmeli Turmetre	Çevirerek	5	3,5 x 5	37 x 30 x Ø 4,1	4.000 / Devir	8,00 \$
LB 102 - 5 V2	Dönmeli Turmetre	Basmalı	5	3,5 x 5	37 x 30 x Ø 4,1	4.000 / Devir	12,00 \$
BM3 10 - 5	Tekstilci Turmetresi	Basmalı	5	4,5 x 6,5	62,5 x 52 x Ø 4,2	30 m / Dakika	105,00 \$



www.konsangroup.com

EL ALETLERİ GRUBU

KSN[®]
EL ALETLERİ



KSN® MEKANİK EL ALETLERİ (Yüksük Sıkma)

İTHALATIMIZ

FC-5 (YAC-5) | 0,50 - 6 mm² Yüksük Sıkma Pensesi**75,00 \$****FC-6 (YAC-6)** | 6 - 16 mm² Yüksük Sıkma Pensesi**75,00 \$****FC-8 (YAC-8)** | Dörtgen / 0,08 - 6 mm² Yüksük Sıkma Pensesi**97,00 \$****FC-9 (YAC-9)** | Altıgen / 0,08 - 6 mm² Yüksük Sıkma Pensesi**112,00 \$****FT-B4 (YYT-B4)** | 0,50 - 6 mm² Yüksük Sıkma Pensesi**70,00 \$****FT-B6 (YYT-B6)** | 6 - 10 - 16 mm² Yüksük Sıkma Pensesi**71,00 \$****FT-B7 (YYT-B7)** | 0,14 - 2,5 mm² Yüksük Sıkma Pensesi**72,00 \$****FC-17 (YAC-17)** | 25 - 35 mm² Yüksük Sıkma Pensesi**78,00 \$****FR-16** | 0,50 - 16 mm² Yüksük Sıkma Pensesi**38,00 \$****NWS-16** | 0.50 - 16mm² Yüksük Sıkma Pensesi**90,00 €**

KSN® MEKANİK EL ALETLERİ (İzoleli ve İzolesiz)

İTHALATIMIZ

HD-0560 | 0,5 - 6 mm²
İzoleli Papuç Sıkma Pensesi

78,00 \$

FT-7 (YYT-7) | 0,5 - 6 mm²
İzoleli Papuç Sıkma Pensesi

76,00 \$

FT-1 (YYT-1) | 0,5 - 10 mm²
İzoleli Papuç Sıkma Pensesi

63,00 \$

HD-FLAG | 0,5 - 2,5 mm²
Bayrak Tip İzoleli Terminal Pensesi

90,00 \$

HD-F 0560 | 0,50 - 6 mm²
İzolesiz Terminal Sıkma Pensesi

78,00 \$

FT-11 (YYT-11) | 0,50 - 6 mm²
İzolesiz Terminal Sıkma Pensesi

76,00 \$

FT-12 (YYT-12) | 1,5 - 2,5 / 4 - 6 / 8 - 10 mm²
İzolesiz Terminal Sıkma Pensesi

77,00 \$

FC-16 (YAC-16) | 1,5 - 2,5 mm²
Eğri Terminal Sıkma Pensesi

90,00 \$

FT-8 (YYT-8) | 1,5 - 10 mm² SKP Sıkma Pensesi

66,00 \$

FT-9 (YYT-9) | 10 - 16 mm² SKP Sıkma Pensesi

66,00 \$

KSN® MEKANİK EL ALETLERİ (SKP ve İzolesiz)

İTHALATIMIZ

FT-15 (YYT-15) | Kablo Kapama
Sıkma Pensesi - AWG 10-12**90,00 \$****FC-12 (YAC-12)** | 28 - 22 / 22 - 18 (AWG)
Konnektör Ucu Sıkma Pensesi (JST)**79,00 \$****FC-13 (YAC-13)** | 28 - 22 / 24 - 18 (AWG)
Konnektör Ucu Sıkma Pensesi (Molex)**79,00 \$****HD-11010** | 24 - 14 (AWG)
Konnektör Sıkma Pensesi**78,00 \$****FC-4 (YAC-4)** | 18 - 22 / 24 - 30 (AWG)
Konnektör Terminal Pensesi**76,00 \$****HD-11011** | 30 - 18 (AWG)
Konnektör Sıkma Pensesi**78,00 \$****FT-B10 (YYT-B10)** | 0,08 - 0,8 mm² (AWG)
28 - 18 Konnektör Terminal Pensesi**74,00 \$****HD - SWLK** | Çelik Tel Kilitleme Konnektör Pensesi**95,00 \$****HY-204J** | 2,5 - 6 mm²
Kablo Kesme Makası**18,00 \$****HY-204P** | 2,5 - 6 mm²
Kablo Kesme Makası**18,00 \$**

KSN® KABLO SOYMA VE KESME ALETLERİ

İTHALATIMIZ

CC-08 | 10 mm² Kablo Kesme Makası



25,00 \$

CC-60 | 60 mm² Bakır ve Alüminyum Kablo Keser



50,00 \$

CC-38 S | 38 mm² Bakır ve Alüminyum Kablo Keser



40,00 \$

CC-250 | 250 mm² Bakır ve Alüminyum Kablo Keser



196,00 \$

FR-C80 | 80 mm² Bakır ve Alüminyum Kablo Keser



66,00 \$

CC-500 | 500 mm² Bakır ve Alüminyum Kablo Keser



320,00 \$

KSN® NETWORK PENSELERİ

İTHALATIMIZ

HY-376E | 8P8C / 6P6C / 6P4C Plug Sıkma Pensesi



38,00 \$

HT-200 | Modüller (4P-4C), (6P-6C), (8P-8C) Plug Sıkma Pensesi



20,00 \$

KD-1 | 1 - 6 mm² İrtibatlama Aleti



10,00 \$

EZ-1 | 8P8C/RJ-45, 6P6C/RJ-11 ve 6P4C/RJ-12 Yeni Nesil Konnektör Pensesi



45,00 \$

KSN® KABLO SOYMA VE KESME ALETLERİ

İTHALATIMIZ

F-318 (YY-78/318) | 0,50 - 6 mm²
Kablo Soyma Pensesi**KP-6** | 0,8 - 6 mm²
Kablo Soyma Pensesi**TP-700A** | 0,50 - 2 mm²
Kablo Soyma Pensesi**TP-700B** | 1,00 - 3,20 mm²
Kablo Soyma Pensesi**HY-150A** | 0,50 - 6 mm²
Kablo Soyma Pensesi**HY-371** | 0,20 - 6 mm²
Kablo Soyma ve Sıkma Pensesi**HY-033** | 0,75 - 6 mm²
Kablo Soyma ve Sıkma Pensesi**HY-5022** | 0,40 - 1,3 mm²
Kablo Soyma ve Kesme Pensesi**HY-223H** | 2 mm²
Kablo Soyma ve Kesme Pensesi**HY-** | 2 mm²
Kablo Soyma ve Kesme Pensesi

,00 \$

KSN® KABLOBAĞI SIKMA PENSELERİ

İTHALATIMIZ

TG-0082,2 - 4,8 mm
Kablo Bağı Sıkma Pensesi**72,00 \$****TG-009**3,6 - 9,0 mm
Kablo Bağı Sıkma Pensesi**51,00 \$****TG-011**4,6 - 12 mm
Çelik Kablo Bağı Sıkma Pensesi**200,00 \$****LY-600N**4,8 - 7,6 mm
Çelik Kablo Bağı Sıkma Pensesi**220,00 \$**

EL ALETLERİ

YETKİLİ BAYİ

JOKARI-102800,4 - 28 mm² arası
NYY-NYM Yuvarlak Kablo Soyma**47,00 €****JOKARI-10282**0,4 - 28 mm² arası
NYY-NYM Yuvarlak Kablo Soyma**38,00 €****JOKARI-20050**1 - 6 mm² Kablo Soyma Pensesi**74,00 €****TRE-03NB**

Elektronikçi Yan Keski

**9,30 €**

KSN® MEKANİK SKP PAPUÇ SIKMA PENSELERİ

İTHALATIMIZ

KSN-0650 | 6,0 - 50 mm²
SKP Sıkma Pensesi (Döner Çene)

-,00 \$

KSN-10120 | 10,0 - 120 mm²
SKP Sıkma Pensesi (Döner Çene)

-,00 \$

KSN-25150 | 25 - 150 mm²
SKP Sıkma Pensesi

-,00 \$

FR-25 (YYR-510) | 8,0 - 25 mm²
SKP Sıkma Pensesi

95,00 \$

ZUPPER HİDROLİK PAPUÇ SIKMA PENSELERİ

İTHALATIMIZ

YQK-70 | 4 - 70 mm² Hidrolik Alüminyum ve Bakır
Kablo Papuç Sıkma Pensesi

125,00 \$

YYQ-120A | 10 - 120 mm² Hidrolik Alüminyum
ve Bakır Kablo Papuç Sıkma Pensesi

155,00 \$

YYQ-120 | 10 - 120 mm² Hidrolik Alüminyum
ve Bakır Kablo Papuç Sıkma Pensesi

150,00 \$

YQK-300 | 10 - 300 mm² Hidrolik Alüminyum
ve Bakır Kablo Papuç Sıkma Pensesi

160,00 \$

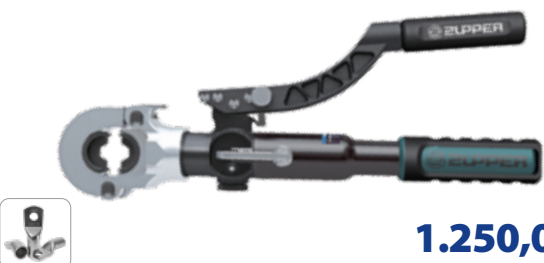
HZ-300 | 16 - 300 mm² Hidrolik Alüminyum
ve Bakır Kablo Papuç Sıkma Pensesi

1.250,00 \$

HZ-400 | 16 - 400 mm² Hidrolik Alüminyum
ve Bakır Kablo Papuç Sıkma Pensesi

1.450,00 \$

No. 4-28 H | 4 - 28 mm Ø
Kablo Soyucu

36,00 €

No. 300 | 0,5 - 6 mm²
Duo-Soyucu

139,00 €

No. 5 | 0,2 - 6 mm²
Kablo Sıyırıcı

56,00 €

No. 5 Pro | 0,2 - 16 mm²
Kablo Sıyırıcı

109,00 €

10100025 | 50 mm²'ye kadar
Kablo Makası XL

42,00 €

10068090 | Düz ve Yuvarlak Kablo Soyucu

32,00 €

10100513 | Altıgen / 0,5 - 16 mm²
Yüksük Sıkma Pensi HEX

120,00 €

10100515 | 0,25 - 6 mm²
Yüksük Sıkma Pensi MULTI

160,00 €

10100516 | 0,25 - 6 mm²
Yüksük Sıkma Pensi ERGO

212,00 €

No. 4 - 29 | 4,5 - 29 mm
Kablo Soyucu Spiral

187,00 €

03 KOMBİNE PENSELER



ÜRÜN NO	UZUNLUK mm	KAFA	SAP	KESME KAPASİTESİ					FİYATI €
				Ømm	Ømm	Ømm	mm ²	gr	
03 01	140	Polisaj	İnce izole	2,8	1,8	9,0	10	112	23,00
	160			3,1	2,0	10,0	16	187	21,00
	180			3,4	2,2	12,0	16	216	22,00
03 02	160	Polisaj	Kalın izole	3,1	2,0	10,0	16	223	28,30
	180			3,4	2,2	12,0	16	260	29,87
	200			3,8	2,5	13,0	16	330	33,83

12 OTOMATİK KABLO SIYIRICI

ÜRÜN NO	UZUNLUK mm	SIYIRMA KAPASİTESİ		ÖZELLİK	gr	FİYATI €
		mm ²	AWG			
12 40	200	0.03-10.0	32-7	Manuel derinlik ayarlamalı	200	101,00
12 50	200	2.5-16.0	13-7	Manuel derinlik ayarlamalı	200	146,00
12 42	195	0.03-10.0	32-7	Otomatik derinlik ayarlamalı	136	135,00
12 62	180	0.2-6.0	24-10	Otomatik derinlik ayarlamalı	151	59,00

97 YÜKSÜK SIKMA PENSİ

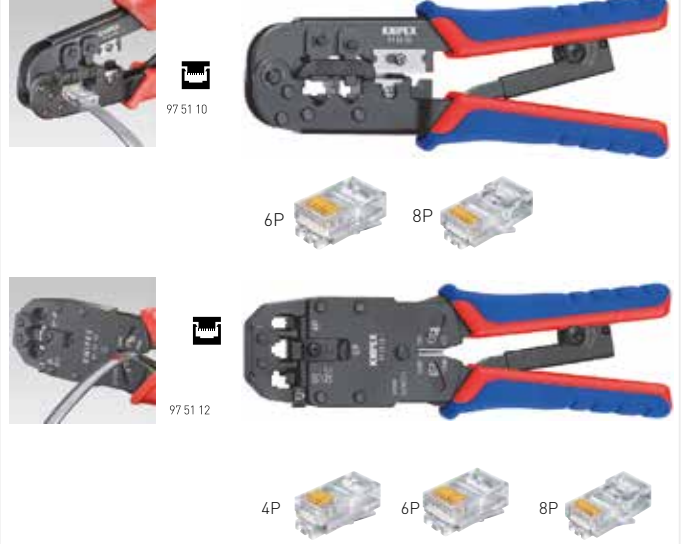
ÜRÜN NO	UZUNLUK mm	FORM	SAP	KULLANMA YERİ	KAPASİTE	gr	FİYATI €
97 53 14	180		Kalın izole	Kablo ucu altı köşe papuç sıkma	0.08-10mm ²	404	251,00
97 53 09	190		Kalın izole	Kablo ucu dört köşe papuç sıkma	0.08-10/16mm ²	486	257,00

97 TELEFONve JAK BAĞLANTI PENSESİ

ÜRÜN NO	UZUNLUK mm	SAP	KULLANMA YERİ	KAPASİTE	gr	FİYATI €
97 51 10	190	İzole	Telefon konnektör kablo bağlantıları	RJ11/12/(6P) RJ45/(8BP)	340	55,70
97 51 12	200	İzole	Telefon konnektör kablo bağlantıları	RJ10(4P) RJ11/12(6P) RJ45(8P)	522	193,20

70 YAN KESKİ

ÜRÜN NO	UZUNLUK (mm)	FORM	KAFA	SAP	KESME DEĞERLERİ			gr	FİYATI €
					Ømm	Ømm	Ømm		
70 01	110		Polisaj	İnce izole	3,0	2,0	1,2	80	27,00
	125				3,0	2,3	1,5	80	27,00
	160				4,0	2,8	2,0	171	27,00
70 02	125		Polisaj	Kalın izole	3,0	2,3	1,5	115	33,91
	140				4,0	2,5	1,8	155	34,41
	160				4,0	2,8	2,0	205	35,47
	180				4,0	3,0	2,5	235	37,60
70 06	125	1000V	Krom	Sarı kırmızı çift bilesimli	3,0	2,3	1,5	120	43,00
	140				4,0	2,5	1,8	160	43,00
	160				4,0	2,8	2,0	205	46,00
	180				4,0	3,0	2,5	255	49,00

KONDANSATÖR GRUBU



www.konsangroup.com



KONDANSATÖR
CAPACITOR



DAİMİ DEVRE MOTOR ve AYDINLATMA KONDANSATÖRLERİ

 KONDANSATÖR
CAPACITOR

KAPASİTE / μ f CBB 60	Ölçüler (mm)	Pls. Tüp Kablolu 400/450V Adet / (\$)	Pls. Tüp Vidalı 250V Adet / (\$)
0,5	25 x 65	1,00 \$	-
1	25 x 65	1,00 \$	-
1,25	25 x 65	1,02 \$	-
1,5	25 x 65	1,03 \$	-
2	25 x 65	1,05 \$	-
2,5	25 x 65	1,11 \$	0,92 \$
3	25 x 65	1,12 \$	0,95 \$
3,15-3,5	25 x 65	1,14 \$	-
4	25 x 65	1,16 \$	0,98 \$
4,5	30 x 65	1,17 \$	1,00 \$
5	30 x 63	1,20 \$	1,10 \$
6	30 x 63	1,35 \$	1,16 \$
6,3-6,5	30 x 63	1,40 \$	-
7	30 x 63	1,45 \$	1,25 \$
7,5	30 x 63	1,46 \$	-
8	30 x 63	1,60 \$	1,33 \$
9	30 x 63	1,76 \$	1,48 \$
10	34 x 63	1,77 \$	1,55 \$
12	34 x 71	1,82 \$	1,68 \$
12,5	34 x 71	1,85 \$	1,72 \$
14	34 x 71	2,35 \$	2,10 \$
15	34 x 71	2,45 \$	2,30 \$
16	34 x 71	2,50 \$	2,35 \$
18	40 x 72	2,52 \$	2,40 \$
20	40 x 72	2,56 \$	2,48 \$
25	40 x 72	3,00 \$	2,80 \$
30	44 x 72	3,45 \$	3,25 \$
32	44 x 72	3,75 \$	3,55 \$
35	44 x 72	3,85 \$	3,70 \$
40	44 x 95	4,25 \$	3,98 \$
45	44 x 95	4,66 \$	4,52 \$
50	48 x 95	4,95 \$	4,76 \$
55	48 x 102	5,25 \$	-
60	48 x 102	5,66 \$	5,55 \$
65	48 x 102	6,75 \$	-
70	55 x 123	7,50 \$	-
80	55 x 123	7,75 \$	7,50 \$
85	55 x 123	8,90 \$	8,35 \$
90	55 x 123	9,30 \$	-
100	58 x 123	9,80 \$	9,30 \$

DAİMİ DEVRE MOTOR KONDS. PLASTİK TÜP VİDALI, TERMINALLİ

KONDANSATÖR
CAPACITOR

KAPASİTE / μf CBB 60	VOLT	Ölçü (mm) Ebatları	Birim Fiyat AD. (\$)
0,5	400 - 450 V	30 x 57	1,10 \$
1	400 - 450 V	30 x 57	1,10 \$
1,5	400 - 450 V	30 x 57	1,15 \$
2	400 - 450 V	30 x 57	1,25 \$
2,5	400 - 450 V	30 x 57	1,30 \$
3	400 - 450 V	30 x 57	1,40 \$
3,15	400 - 450 V	30 x 57	1,43 \$
4	400 - 450 V	35 x 65	1,45 \$
4,5	400 - 450 V	35 x 65	1,48 \$
5	400 - 450 V	35 x 65	1,55 \$
6	400 - 450 V	35 x 65	1,70 \$
7	400 - 450 V	35 x 65	1,75 \$
7,5	400 - 450 V	35 x 65	1,80 \$
8	400 - 450 V	35 x 65	1,85 \$
9	400 - 450 V	35 x 65	2,19 \$
10	400 - 450 V	35 x 65	2,20 \$
12,5	400 - 450 V	40 x 70	2,60 \$
15	400 - 450 V	40 x 70	2,82 \$
16	400 - 450 V	40 x 70	2,94 \$
18	400 - 450 V	40 x 70	3,16 \$
20	400 - 450 V	40 x 70	3,26 \$
25	400 - 450 V	45 x 95	3,66 \$
30	400 - 450 V	45 x 95	4,21 \$
35	400 - 450 V	50 x 106	4,71 \$
40	400 - 450 V	50x 106	5,32 \$
45	400 - 450 V	50 x 106	5,97 \$
50	400 - 450 V	50 x 106	6,42 \$
55	400 - 450 V	50 x 106	6,95 \$
60	400 - 450 V	50 x 106	7,23 \$
70	400 - 450 V	50 x 116	9,40 \$
80	400 - 450 V	60 x 120	10,50 \$
90	400 - 450 V	60 x 120	12,50 \$
100	400 - 450 V	60 x 120	14,00 \$

PLASTİK TÜP, VİDALI, KABLOLU

KAPASİTE / μf CBB 61	VOLT	Ölçü (mm) Ebatları	Birim Fiyat AD. (\$)
1	400 - 450 V	30 x 65	1,50 \$
1,5	400 - 450 V	30 x 65	1,60 \$
2,5	400 - 450 V	30 x 65	1,75 \$
3,5	400 - 450 V	30 x 65	1,85 \$

MOTOR İLK HAREKET (START) KONDANSATÖRLERİ

 KONDANSATÖR
CAPACITOR

KAPASİTE (µf)	ÇAP (mm)	VOLT	HAWCON AD. (\$)	KAPASİTE (µf)	EKON AD. (\$)
36 - 43	36	250V	2,40 \$	36 - 43	4,60 \$
43 - 53	36	250V	2,50 \$	43 - 53	5,22 \$
47 - 56	36	250V	2,65 \$	47 - 56	5,32 \$
53 - 64	36	250V	2,75 \$	56 - 64	5,37 \$
64 - 77	36	250V	2,90 \$	64 - 77	5,45 \$
72 - 88	36	250V	3,00 \$	72 - 88	5,58 \$
88 - 108	36 - 46	250V	3,15 \$	88 - 108	5,88 \$
108 - 130	36 - 46	250V	3,70 \$	108 - 130	6,15 \$
124 - 149	36 - 46	250V	3,85 \$	124 - 149	6,37 \$
130 - 156	36 - 46	250V	4,00 \$	130 - 156	6,50 \$
145 - 175	36 - 46	250V	4,30 \$	145 - 175	7,39 \$
161 - 193	46	250V	4,45 \$	161 - 193	7,80 \$
189 - 227	46	250V	4,60 \$	189 - 227	8,66 \$
216 - 259	46	250V	4,90 \$	216 - 259	9,10 \$
233 - 280	46	250V	5,75 \$	233 - 280	9,60 \$
280 - 333	46	250V	5,98 \$	280 - 333	11,10 \$



KONDANSATÖR GRUBU

MOTOR İLK HAREKET (START) KONDANSATÖRLERİ



KAPASİTE (µf)	ÇAP (mm)	VOLT	AD. (\$)
64 - 77	36 x 86	330V	3,60 \$
88 - 108	36 x 86	330V	3,85 \$
124 - 149	36 x 86	330V	4,55 \$
145 - 175	36 x 86	330V	5,18 \$
189 - 227	46 x 86	330V	6,00 \$
233 - 280	46 x 86	330V	6,85 \$
280 - 333	46 x 86	330V	7,80 \$
340 - 408	52 x 86	330V	9,50 \$
378 - 454	52 x 110	330V	9,80 \$
400 - 480	52 x 110	330V	10,00 \$
430 - 516	52 x 110	330V	11,00 \$
460 - 552	52 x 110	330V	12,00 \$

FAN KONDANSATÖRLERİ KARE TİP



KAPASİTE / μ f CBB 61	VOLT	Ölçü (mm) Ebatları	Birim Fiyat AD. (\$)
0,5	400 - 450 V	36x11 x 22	0,75 \$
0,9	400 - 450 V	36x11 x 22	0,76 \$
1	400 - 450 V	36x11 x 22	0,80 \$
1,25	400 - 450 V	36x11 x 22	0,83 \$
1,5	400 - 450 V	38x13,5 x 24	0,87 \$
2	400 - 450 V	38x15 x 25	0,90 \$
2,5	400 - 450 V	38x15 x 25	0,95 \$
3	400 - 450 V	38x15 x 25	1,03 \$
3,5	400 - 450 V	38x15 x 25	1,15 \$
4	400 - 450 V	47x17 x 28	1,20 \$
5	400 - 450 V	47x20,5 x 33	1,35 \$
6	400 - 450 V	47x 20,5 x 33	1,40 \$
7	400 - 450 V	48 x 22 x 35	1,50 \$
8	400 - 450 V	47 x 22 x 35	1,56 \$
10	400 - 450 V	47 x 25 x 35	1,85 \$
12	400 - 450 V	47 x 26 x 38	2,10 \$
15	400 - 450 V	57 x 23 x 40	2,40 \$
16	400 - 450 V	58 x 28 x 40	2,58 \$
20	400 - 450 V	58 x 28 x 40	2,60 \$
25	400 - 450 V	58 x 32 x 43	3,15 \$

ALÜMİNYUM TÜP, VİDALI, TERMİNALLI



KAPASİTE / μ f CBB 65	VOLT	Ölçü (mm) Ebatları	Birim Fiyat AD. (\$)
2	400 - 450 V	40 x 70	1,45 \$
3	400 - 450 V	40 x 70	1,55 \$
4	400 - 450 V	40 x 70	1,70 \$
5	400 - 450 V	40 x 70	1,85 \$
6	400 - 450 V	40 x 70	1,95 \$
8	400 - 450 V	40 x 70	2,20 \$
10	400 - 450 V	40 x 70	2,50 \$
12,5	400 - 450 V	40 x 70	2,70 \$
15	400 - 450 V	40 x 60	3,25 \$
20	400 - 450 V	40 x 75	3,85 \$
25	400 - 450 V	45 x 75	4,15 \$
30	400 - 450 V	50 x 85	4,50 \$
35	400 - 450 V	50 x 100	5,50 \$
40	400 - 450 V	50 x 100	5,70 \$
45	400 - 450 V	50 x 110	6,40 \$
50	400 - 450 V	50 x 110	6,75 \$
55	400 - 450 V	50 x 110	7,70 \$
60	400 - 450 V	50 x 125	8,50 \$
70	400 - 450 V	50 x 125	11,00 \$
80	400 - 450 V	50 x 125	11,35 \$
90	400 - 450 V	50 x 125	12,90 \$
100	400 - 450 V	55 x 125	14,00 \$



ZnPP STANDART KUTU TİPİ 3 FAZ ALÇAK GERİLİM GÜÇ KONDANSATÖRLERİ

ÜRÜN KODU	GERİLİM	400 V	415 V		KAPASİTE (µf)	KOLİ AD.	AD. / ₺
ZG12D01B0	400 V, 50 Hz, Güç/kVAr	0.5	0.53		10	12	540,00 ₺
ZG12D01D0		1.0	1.1		20	12	567,00 ₺
ZG12D01G0		1.5	1.6		30	12	594,00 ₺
ZG12D01K0		2.5	2.7		50	12	702,00 ₺
ZG12D01S0		5.0	5.4		100	12	940,00 ₺
ZG12D01V0		7.5	8.1		150	6	1.134,00 ₺
ZG12D01X0		10.0	10.8		200	6	1.296,00 ₺
ZG12D01Y0		12.5	13.5		250	6	1.458,00 ₺
ZG12D0160		15.0	16.1		300	6	1.782,00 ₺
ZG12D0180		20.0	21.5		400	6	2.268,00 ₺
ZG12D0190		25.0	26.9		500	6	2.646,00 ₺
ZG12D0A00		30.0	32.3		600	6	3.348,00 ₺
ZG12D0280		40.0	43.0		800	3	4.806,00 ₺
ZG12D0290		50.0	53.8		1000	3	5.562,00 ₺
ZG12D02A0	60.0	64.6		1200	3	6.372,00 ₺	

ÜRÜN KODU	GERİLİM	440 V	400 V	415 V	KAPASİTE (µf)	KOLİ AD.	AD. / ₺
ZJ12D01B0	440 V, 50 Hz, Güç/kVAr	0.5	0.4	0.4	8,22	12	540,00 ₺
ZJ12D01D0		1.0	0.8	0.9	16,5	12	567,00 ₺
ZJ12D01G0		1.5	1.2	1.3	25	12	594,00 ₺
ZJ12D01K0		2.5	2.1	2.2	41	12	702,00 ₺
ZJ12D01S0		5.0	4.1	4.4	82,5	12	940,00 ₺
ZJ12D01V0		7.5	6.2	6.7	123,6	6	1.134,00 ₺
ZJ12D01X0		10.0	8.3	8.9	164,7	6	1.296,00 ₺
ZJ12D01Y0		12.5	10.0	11.1	206	6	1.458,00 ₺
ZJ12D0160		15.0	12.5	13.3	247	6	1.782,00 ₺
ZJ12D0180		20.0	16.5	17.8	330	6	2.268,00 ₺
ZJ12D0190		25.0	20.0	22.2	411	4	2.646,00 ₺
ZJ12D0A00		30.0	25.0	26.7	493,5	6	3.348,00 ₺
ZJ12D0280		40	33.0	35.6	660	3	4.806,00 ₺
ZJ12D0290		50	40.0	44.4	822	3	5.562,00 ₺
ZJ12D02A0	60	50.0	53.7	987	3	6.372,00 ₺	



ÜRÜN KODU	GERİLİM	525 V	440 V	480 V	KAPASİTE (µf)	KOLİ AD.	AD. / ₺
ZO12D01K0	525 V, 50 Hz, Güç/kVAr	2.5	1.8	2.1	29	12	702,00 ₺
ZO12D01S0		5.0	3.5	4.2	58	12	940,00 ₺
ZO12D01V0		7.5	5.3	6.2	87	6	1.134,00 ₺
ZO12D01X0		10.0	7.0	8.3	116	6	1.296,00 ₺
ZO12D01Y0		12.5	8.8	10.4	145	6	1.458,00 ₺
ZO12D0160		15.0	10.5	12.5	173	6	1.782,00 ₺
ZO12D0180		20.0	14.1	16.6	231	6	2.268,00 ₺
ZO12D0190		25.0	17.5	20.8	289	4	2.646,00 ₺
ZO12D0A00		30.0	21.1	25.0	348	4	3.348,00 ₺
ZO12D0280		40.0	28.2	33.3	462	2	4.806,00 ₺
ZO12D0290		50.0	35.0	41.7	578	2	5.562,00 ₺
ZO12D02A0		60	42.2	50.0	696	3	6.372,00 ₺

ÜRÜN KODU	GERİLİM	690 V	690 V	KAPASİTE (µf)	KOLİ AD.	AD. / ₺
ZX12S01X0	690 V, 50 Hz, Güç/kVAr	10.0	10.0	66.9	6	1.960,00 ₺
ZX12S01Y0		12.5	12.5	83.6	6	2.453,00 ₺
ZX12S0180		20.0	20.0	133.8	6	3.864,00 ₺
ZX12S0190		25.0	25.0	167.2	4	4.772,00 ₺

ZnPP STANDART KUTU TİPİ 1-2 (MONOFAZ - DİFAZ) ALÇAK GERİLİM GÜÇ KOND.

ÜRÜN KODU	GERİLİM	230 V	400 V		KAPASİTE (µf)	KOLİ AD.	AD. / ₺
Z412M01A0	230 V, 50 Hz, Güç/kVAr	0.25	0.75		15	12	471,00 ₺
Z412M01B0		0.5	1.5		30	12	504,00 ₺
Z412M01D0		1.0	3.0		60	12	560,00 ₺
Z412M01G0		1.5	4.5		90	12	616,00 ₺
Z412M01K0		2.5	7.5		150	12	751,00 ₺
Z412M01S0		5.0	15.0		300	6	1.456,00 ₺
Z412M01X0		10.0	30.0		600	4	2.744,00 ₺



GÜÇ KONDASATÖRLERİ

YETKİLİ BAYI

ZnPS SİLİNDİRİK TİP 3 FAZ ALÇAK GERİLİM GÜÇ KONDANSATÖRLERİ



ÜRÜN KODU	GERİLİM	400 V	415 V		KAPASİTE (µf)	KOLİ AD.	AD. / ʘ
YG12D01B0	400 V, 50 Hz, Güç/kVAr	0.5	0.53		10	12	589,00 ʘ
YG12D01D0		1.0	1.1		20	12	605,00 ʘ
YG12D01G0		1.5	1.6		30	12	633,00 ʘ
YG12D01K0		2.5	2.7		50	12	748,00 ʘ
YG12D01S0		5.0	5.4		100	12	1.012,00 ʘ
YG12D01V0		7.5	8.1		150	6	1.296,00 ʘ
YG12D01X0		10.0	10.8		200	6	1.448,00 ʘ
YG12D01Y0		12.5	13.5		250	6	1.674,00 ʘ
YG12D0160		15.0	16.1		300	6	1.944,00 ʘ
YG12D0180		20.0	21.5		400	6	2.430,00 ʘ
YG12D0190		25.0	26.9		500	4	2.700,00 ʘ
YG12D0A00		30.0	32.3		600	4	3.024,00 ʘ

ÜRÜN KODU	GERİLİM	440 V	400 V	415 V	KAPASİTE (µf)	KOLİ AD.	AD. / ʘ
YJ12D01B0	440 V, 50 Hz, Güç/kVAr	0.5	0.4	0.4	8,22	12	589,00 ʘ
YJ12D01D0		1.0	0.8	0.9	16,5	12	605,00 ʘ
YJ12D01G0		1.5	1.2	1.3	25	12	633,00 ʘ
YJ12D01K0		2.5	2.1	2.2	41	12	748,00 ʘ
YJ12D01S0		5.0	4.1	4.4	82,5	12	1.012,00 ʘ
YJ12D01V0		7.5	6.2	6.7	123,6	6	1.296,00 ʘ
YJ12D01X0		10.0	8.3	8.9	164,7	6	1.448,00 ʘ
YJ12D01Y0		12.5	10.0	11.1	206	6	1.674,00 ʘ
YJ12D0160		15.0	12.5	13.3	247	6	1.944,00 ʘ
YJ12D0180		20.0	16.5	17.8	330	6	2.430,00 ʘ
YJ12D0190		25.0	20.0	22.2	411	4	2.700,00 ʘ
YJ12D0A00		30.0	25.0	26.7	493,5	4	3.024,00 ʘ

ÜRÜN KODU	GERİLİM	480 V	440 V		KAPASİTE (µf)	KOLİ AD.	AD. / ʘ
YY12D0170	480 V, 50 Hz, Güç/kVAr	16,6	14,1	2 FAZ 2 UÇLU	230	6	2.184,00 ʘ
YY12D0H00		33,3	28,2		460	4	3.528,00 ʘ
YY12P0H00		33,3	28,2		460	4	3.528,00 ʘ



ÜRÜN KODU	GERİLİM	525 V	440 V	480 V	KAPASİTE (µf)	KOLİ AD.	AD. / ʘ
YO12D01K0	525 V, 50 Hz, Güç/kVAr	2.5	1.8	2.1	29	12	748,00 ʘ
YO12D01S0		5.0	3.5	4.2	58	12	1.012,00 ʘ
YO12D01V0		7.5	5.3	6.2	87	6	1.296,00 ʘ
YO12D01X0		10.0	7.0	8.3	116	6	1.448,00 ʘ
YO12D01Y0		12.5	8.8	10.4	145	6	1.674,00 ʘ
YO12D0160		15.0	10.5	12.5	173	6	1.944,00 ʘ
YO12D0180		20.0	14.1	16.6	231	6	2.430,00 ʘ
YO12D0190		25.0	17.5	20.8	289	4	2.700,00 ʘ
YO12D0A00		30.0	21.1	25.0	348	4	3.024,00 ʘ
YO12D0280		40.0	28.2	33.3	462	2	4.180,00 ʘ
YO12D0290		50.0	35.0	41.7	578	2	5.170,00 ʘ

ZnPS SİLİNDİRİK TİP 1-2 (MONOFAZE - DİFAZE) ALÇAK GERİLİM GÜÇ KOND.



ÜRÜN KODU	GERİLİM	230 V	400 V		KAPASİTE (µf)	KOLİ AD.	AD. / ʘ
Y412M01A0	230 V, 50 Hz, Güç/kVAr	0.25	0.75		15,1	12	600,00 ʘ
Y412M01B0		0.5	1.5		30,1	12	644,00 ʘ
Y412M01D0		1.0	3.0		60,2	12	840,00 ʘ
Y412M01G0		1.5	4.5		90,3	12	1.008,00 ʘ
Y412M01K0		2.5	7.5		150,5	12	1.288,00 ʘ
Y412M01S0		5.0	15.0		301	6	1.960,00 ʘ
Y412M01X0		10.0	30.0		602	4	3.080,00 ʘ

LEHİM TELLERİ VE HAVYA GRUBU



www.konsangroup.com



CLASS

SOLOMON

ERTAN

Pro'sKit®

ER-SA Weller®

LEHİM TELLERİ

Feray **SOLDEX**

Kurteş



CİNSİ	MAKARA	FERAY	SOLDEX	KURTEL
60 / 40 0,50 mm	500 gr	---	68,00 \$	---
0,75 mm	500 gr	2.200,00 ₺	54,00 \$	40,00 \$
0,80 mm	500 gr	2.200,00 ₺	---	---
1,00 mm	500 gr	2.180,00 ₺	54,00 \$	40,00 \$
1,20 mm	500 gr	2.177,00 ₺	54,00 \$	39,90 \$
1,60 mm	500 gr	2.175,00 ₺	54,00 \$	39,80 \$
2,00 mm	500 gr	2.170,00 ₺	54,00 \$	---
3,00 mm	500 gr	2.170,00 ₺	54,00 \$	---
4,00 mm	500 gr	2.170,00 ₺	54,00 \$	---
40 / 60 1,60 mm	500 gr	1.580,00 ₺	43,00 \$	32,00 \$
30 / 70 1,60 mm	500 gr	1.280,00 ₺	35,00 \$	28,00 \$
60 / 40 Arax	500 gr	2.180,00 ₺	55,00 \$	---
96 S Gümüş	500 gr	8.180,00 ₺	---	---
60/40 Çubuk	Kg.	3.950,00 ₺	---	---

CİNSİ	MAKARA	FERAY	SOLDEX	KURTEL
60 / 40 0,50 mm	100 gr	---	12,50 \$	---
0,75 mm	100 gr	---	10,00 \$	---
1,00 mm	100 gr	---	10,00 \$	---
1,20 mm	100 gr	---	10,00 \$	---
60 / 40 0,50 mm	200 gr	---	23,00 \$	---
0,75 mm	200 gr	880,00 ₺	17,00 \$	17,00 \$
1,00 mm	200 gr	880,00 ₺	17,00 \$	17,00 \$
1,20 mm	200 gr	877,00 ₺	17,00 \$	16,90 \$
1,60 mm	200 gr	877,00 ₺	17,00 \$	16,80 \$
40 / 60 1,60 mm	200 gr	637,00 ₺	14,00 \$	---
30 / 70 1,60 mm	200 gr	520,00 ₺	11,00 \$	---
Tüp Lehim	25 gr	320,00 ₺	7,50 \$	3,50 \$

KURŞUNSUZ LEHİM TELLERİ

CİNSİ	MAKARA	FERAY	SOLDEX	KURTEL
Sn99,3, Cu0,7 0,50 mm	500 gr	---	102,00 \$	---
Sn99,3, Cu0,7 0,75 mm	500 gr	---	78,00 \$	---
Sn99,3, Cu0,7 1,00 mm	500 gr	---	78,00 \$	---
Sn99,3, Cu0,7 1,20 mm	500 gr	2.550,00 ₺	78,00 \$	---
Sn99,3, Cu0,7 1,60 mm	500 gr	---	78,00 \$	---
Sn99,3, Cu0,7 0,50 mm	200 gr	---	41,00 \$	---
Sn99,3, Cu0,7 1,20 mm	200 gr	---	32,00 \$	---

LEHİM SUYU FLUX



CİNSİ	LİTRE	AD. (₺) FERAY
PC - 26	1 LT	210,00 ₺ / NET
PC - 33	1 LT	221,00 ₺ / NET
FSW - 32	1 LT	202,00 ₺ / NET
ARAX FLUX	1 LT	150,00 ₺ / NET
NO - CLEAN	1 LT	205,00 ₺ / NET
ROL - 0	1 LT	205,00 ₺ / NET
HİDRO - X	1 LT	185,00 ₺ / NET
PC - 70 - TİNER	1 LT	165,00 ₺ / NET

CİNSİ	LİTRE	AD. (\$) SOLDEX
SR - 33	1 LT / Soldex	17,00 \$
İZO PROPİL ALKOL	1 LT / Soldex	13,00 \$
SRT - 33 TİNER	1 LT / Soldex	16,00 \$
ARAX	1 LT / Soldex	12,00 \$

PURİNE - STANNOL - FELDER - HAWCON LEHİM PASTALARI



CİNSİ	GRAMAJ	Fiyat / Adet
FELDER Lehim Pastası	50 Gr	3,00 €
FELDER Lehim Pastası	100 Gr	7,00 €
FELDER Lehim Pastası	250 Gr	10,50 €
HAWCON Silikon Isı Transfer Pastası	40 Gr	2,70 \$
HAWCON Silikon Isı Transfer Pastası	150 Gr	6,50 \$
HAWCON Silikon Isı Transfer Pastası	250 Gr	10,00 \$
HAWCON Silikon Isı Transfer Pastası	500 Gr	20,00 \$
HAWCON Silikon Isı Transfer Pastası	1 Kg	38,00 \$
HAWCON Lehim Pastası	50 Gr	2,00 \$
HAWCON Lehim Pastası	100 Gr	3,80 \$
HAWCON Lehim Pastası	250 Gr	8,20 \$
FERAY Lehim Pastası	80 Gr	220,00 ₺
Krem Lehim Enjektörde / SOLDEX	10 Gr	7,50 \$
SOLDEX Lehim Pastası	50 Gr	4,00 \$
SOLDEX Lehim Pastası	100 Gr	6,50 \$
SOLDEX Lehim Pastası	250 Gr	14,00 \$
KALIP NİŞADIR (Havya ucu temizleme)	250 Gr	9,50 \$
CURUF AYRIŞTIRICI (Potalar İçin)	250 Gr	15,00 \$

Weller® LEHİM TABANICALAR VE KALEM HAVYALAR

WLG940023C Lehim Tabancası



- 480°C kullanım sıcaklığı
- 140 Watt,
- 230 Volt,
- 50 Hz

KOD: WLG940023C

80,60 € / Adet

WLG9400K23C Lehim Tabancası



- 480°C kullanım sıcaklığı
- 140 Watt,
- 230 Volt,
- 50 Hz

Standart Ekipmanlar

Konik uç, kesme ucu, düz uç, altıgen anahtar, lehim makarası

KOD: WLG9400K23C

96,80 € / Adet

Lehim Pompası



Ürün No	Açıklama	AD. / €
SA-21A	Lehim Pompası (Metal Gövde)	43,00 €

Havya Aksesuarları

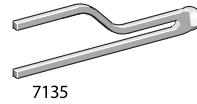

7135

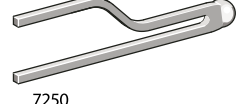

7250

KOD	Kul. Lehim Tabancası	Açıklama	AD. / €
7135	8100 - 9200	Bakır Havya Ucu (2 Adet)	7,90 €
6150	05C	Demir K.Havya Ucu (1 Ad.)	17,40 €

SL Serisi Kalem Havyalar



KOD	WATT	VOLT	HZ	UÇ	⚖️	AD. / €
SL-120	120	230	50	12,5 mm	930 gr	100,50 €
SL-175	175	230	50	16 mm	1030 gr	121,70 €
SL-251	200	230	50	20 mm	1190 gr	148,80 €

SL Serisi Kalem Havyalar



43111

43112

S-41

S-7

KOD	UYUMLU	KAPLAMA	ŞEKİL	ÇAP / UÇ	AD. / €
S-7	SL100-120	Nikel	Eğik	12,5 mm	29,20 €
S-41	SL120	Demir	Eğik	12,5 mm	33,12 €
43111	SL175	Nikel	Eğik	16,0 mm	31,93 €
43112	SL251	Nikel	Eğik	20,0 mm	49,80 €

WLSK3023C / 30W Lehimleme İstasyonu



- Azami sıcaklık 400 °C
- Güç Tüketimi 30W
- Şebeke gerilimi 230 V / 50Hz

* WLIR3023C yedek uçları ile uyumludur.

KOD: WLSK3023C

116,60 € / Adet

WLSK8023C / 80W Lehimleme İstasyonu



- Azami sıcaklık 485 °C
- Güç Tüketimi 80W
- Şebeke gerilimi 230 V / 50Hz

* WLIR8023C yedek uçları ile uyumludur.

KOD: WLSK8023C

136,50 € / Adet

SPI Serisi Kalem Havyalar



W-101

W-61

W-201

Ürün No	Açıklama	AD. / €
T005 61 036 99	W-61 60W Termikli Kalem Havya	174,00 €
T005 61 096 99	W-101 100W Termikli Kalem Havya	195,00 €
T005 61 056 99	W-201 200W Termikli Kalem Havya	249,00 €

SPI Serisi Kalem Havyalar



15-25-40 W

80 W

Ürün No	Açıklama	AD. / €
T005 64 005 99	SPI-16 15W Kalem Havya	102,00 €
T005 64 021 99	SPI-27 25W Kalem Havya	102,00 €
T005 64 037 99	SPI-41 40W Kalem Havya	102,00 €
T005 64 053 99	SPI-81 75W Kalem Havya	117,00 €

Weller® KALEM HAVYALAR VE İSTASYON HAVYALARI

WLIRK3023C / 30W LED'li Kalem Havya Seti



- 400°C kullanım sıcaklığı,
- 30 Watt
- 230 Volt, 50 Hz
- Uç tipi model Serisi 4 mm (5/16")

KOD: WLIRK3023C

46,80 € / Adet

WLIR3023C UYUMLU HAVYA UÇLARI



KOD	AÇIKLAMA	AD. / €
WLTK4IR30	Bıçak Havya Ucu 4 mm 3'lü	11,10 €
WLTC08IR30	Konik Havya Ucu 0.8 mm 3'lü	16,64 €
WLCH4IR30	Keski Havya Ucu 4 mm 3'lü	11,10 €
WLTS4IR30	Keski Havya Ucu 4 mm 3'lü	11,10 €

WLIR6023C / 60W LED'li Kalem Havya Seti



- 425°C kullanım sıcaklığı,
- 60 Watt
- 230 Volt, 50 Hz
- Uç Tipi model Serisi 6 mm (1/4")

KOD: WLIR6023C

53,30 € / Adet

WLIR3023C UYUMLU HAVYA UÇLARI



KOD	AÇIKLAMA	AD. / €
WLTC08IR60	Konik Havya Ucu 0,8 mm 3'lü	17,55 €
WLTC04IR60	Konik Havya Ucu 0,4 mm 3'lü	17,55 €
WLCH6IR60	Keski Havya Ucu 6,4 mm 3'lü	13,00 €
WLTS24IR60	Keski Havya Ucu 2,4 mm 3'lü	13,00 €

WLIR8023C / 80W LED'li Kalem Havya Seti



- Azami sıcaklık 485 °C
- Güç Tüketimi 80W
- Şebeke gerilimi 230 V / 50Hz
- Uç Tipi model Serisi 10 mm (3/8")

KOD: WLIR8023C

61,10 € / Adet

WLIR8023C UYUMLU HAVYA UÇLARI



KOD	AÇIKLAMA	AD. / €
WLCH10IR80	Keski Havya Ucu 10 mm 3'lü	22,17 €
WLCH60IR80	Keski Havya Ucu 6,4 mm 3'lü	22,17 €
WLTSB10IR80	Eğri Keski Havya Ucu 10 mm 3'lü	29,40 €
WLTS10IR80	Keski Havya Ucu 10 mm 3'lü	29,40 €

WLIBA4/ 4.5W Akülü Havya



- Güç Tüketimi: 4,5 W
- Akü : 4,5 V



Konik Havya Ucu 0,3 mm 3'lü

KOD: WLIBA4

38,87 € / Ad.

KOD: WLTC03IBA4

26,00 € / Ad.

WPS 18MPEU / LED'li Yüksek Performanslı Havya



- 480°C kullanım sıcaklığı
- 35 saniyede ısınmaktadır
- 0.8mm havya ucu
- 18 Watt,
- 9V, DC

KOD: WPS 18MPEU

70,10 € / Adet

WLIRK3023C / 30W LED'li Kalem Havya Seti



- 400°C kullanım sıcaklığı,
 - 30 Watt
 - 230 Volt, 50 Hz
 - 293 gr
 - 0.8 mm
- Standart Ekipmanlar
WLIR3023C Havya,
Keski Havya Ucu 4 mm,
Konik Havya Ucu 0.8 mm,
Lehim Makarası

KOD: WLIRK3023C

50,30 € / Adet

WLIRK6023C / 60W LED'li Kalem Havya Seti



- 425°C kullanım sıcaklığı,
 - 60 Watt
 - 230 Volt, 50 Hz
 - 330 gr
 - 6.4 mm
- Standart Ekipmanlar
WLIR6023C Havya,
Keski Havya Ucu 2.4 / 6.4 mm,
Konik Havya Ucu 0.8 mm,
Lehim Makarası

KOD: WLIRK6023C

63,70 € / Adet

CLASS HAVYA GRUBU

ZD-200 C Kalem Havya



- Güçlü mika rezistans
- Hafif ve Ergonomik
- Uçtan somunlu tasarım
- Topraklı elektrik kablosu
- Blister paketli

Ürün No	Güç	Fiyatı / \$
ZD 200C - 30	30 W	7,50 \$
ZD 200C - 40	40 W	7,50 \$
ZD 200C - 60	60 W	10,50 \$

ZD-200 C Kalem Havya Uçları



Ürün No	Fiyatı / \$
C1-1	1,60 \$
C1-2	1,60 \$

ZD-407 Kalem Havya



- Güçlü mika rezistans
- Hafif ve Ergonomik
- Uçtan vidalı tasarım
- Topraklı elektrik kablosu
- Blister paketli

Ürün No	Güç	Fiyatı / \$
ZD 407C - 30	30 W	7,50 \$
ZD 407C - 40	40 W	7,50 \$
ZD 407C - 60	60 W	10,50 \$

ZD-407 Kalem Havya Uçları

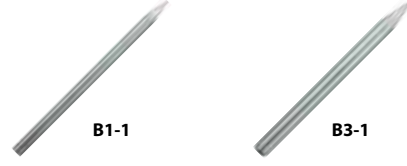

Ürün No	Fiyatı / \$
B1-1	1,60 \$
B3-1	2,60 \$

ZD-401 Kalem Havya



- Güçlü mika rezistans
- Hafif ve Ergonomik
- Uçtan vidalı tasarım
- Topraklı elektrik kablosu
- Blister paketli

Ürün No	Güç	Fiyatı / \$
ZD 401C - 80	80 W	11,00 \$
ZD 401C - 100	100 W	12,50 \$

ZD-401 Kalem Havya Uçları

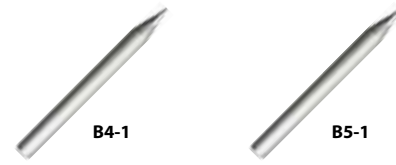

Ürün No	Fiyatı / \$
B4-1	3,30 \$
B5-1	4,30 \$

ZD-715L Yüksek Güçlü Havya



- Açma / kapama anahtarlı
- Güçlü mika rezistans
- İzoleli tutacak yeri
- Hafif ve Ergonomik
- Uçtan vidalı tasarım
- Topraklı elektrik kablosu
- Metal Stand
- Blister paketli

Ürün No	Güç	Fiyatı / \$
ZD 715L - 150	150 W	28,00 \$
ZD 715L - 200	200 W	34,00 \$
ZD 715L - 300	300 W	43,00 \$

ZD-715L 150W Havya Uçu



Ürün No	Fiyatı / \$
Y3-1	14,00 \$

JCD-908S 80W Isı Ayarlı Havya



Ürün No	Güç	Fiyatı / \$
JCD-908S	80 W	25,00 \$

ZD-99 Lehimleme İstasyonu



Kalem Havya
Güç : 48 Watt
Isı Aralığı : 200°C - 480°C

KOD: ZD-99	37,00 \$ / Adet
------------	-----------------

Yihua 936B Havya ve Lehimleme İstasyonu

- Bükülmeyecek ve daha uzun ömürlü olmayacak yüksek kaliteli seramik ısıtıcıyı uygular.
- Anti-statik tasarım, hassas bileşenlerin hasar görmesini etkili bir şekilde önler.

Güç : 40 Watt
Isı Aralığı : 200°C - 480°C
Sıcaklık Kararlılığı : ±10 °C (statik)

KOD: 936B

50,00 \$ / Adet

Yihua 937D Havya ve Lehimleme İstasyonu

- Dijital Ekran
- Bükülmeyecek ve daha uzun ömürlü olmayacak yüksek kaliteli seramik ısıtıcıyı uygular.
- Anti-statik tasarım, hassas bileşenlerin hasar görmesini etkili bir şekilde önler.

Güç : 40 Watt
Isı Aralığı : 200°C - 480°C
Sıcaklık Kararlılığı : ±10 °C (statik)

KOD: 937D

56,00 \$ / Adet

Yihua 852D+ Diyafram Isı Ayarlı Sıcak Hava Üfleme Havya

Makine gücü: 600W ± 10% (MAX)
Çalışma ortamı: 0°C ~ 40 °C bağıl nem <%80
Depolama sıcaklığı: -20 ~ 80 °C bağıl nem <%80

Sıcak Hava Tabancası / Lehimleme

Çıkış gücü: 550W / 60W
Sıcaklık aralığı: 100°C ~ 500 °C / 100°C ~ 500°C
Hava akışı modu: Brushless Koldan üfleme / -
Hava akımı: 24-28L / dakika (maks) /
Sıcaklık kararlılığı: ± 15 °C (statik) / ± 10 °C (statik)
Isıtıcı: Isıtmalı çekirdekten seramik ısıtıcı / Ortak ısıtıcı

KOD: 852D+

108,00 \$ / Adet

Yihua 878D Havya ve Lehimleme İstasyonu

Kalem Havya
Güç : 60 Watt
Isı Aralığı : 200°C - 480°C

Sıcak Hava Üfleme
Güç : 740 Watt
Isı Aralığı : 100°C - 480°C

KOD: 878D

90,00 \$ / Adet

936 A Lehimleme İstasyonu

- Analog
 - Kolay ısı ayarı
 - Yüksek hassasiyet
 - Güçlü seramik rezistans
- Kalem Havya
Güç : 60 Watt
Isı Aralığı : 200°C - 480°C
Çıkış Voltajı: 24V AC

KOD: 936 A

58,00 \$ / Adet

968D Lehimleme ve Sıcak Hava İstasyonu

- Kolay ısı ayarı
- Brushless Fan (Koldan fanlı)
- Otomatik uyku fonksiyonu

Kalem Havya
Güç : 60 Watt
Isı Aralığı : 200°C - 480°C

Sıcak Hava Üfleme
Güç : 500 Watt
Isı Aralığı : 100°C - 500°C

KOD: 968D

112,00 \$ / Adet

ZD-192 Lehim Pompası

Metal

KOD: ZD-192 5,00 \$ / Adet

ZD-10 A Havya Sehpa

KOD: ZD-10 A 4,00 \$ / Adet

938 A Lehimleme İstasyonu

- Dijital LED ekran
 - Kolay ısı ayarı
 - Yüksek hassasiyet
 - Güçlü seramik rezistans
- Kalem Havya
Güç : 60 Watt
Isı Aralığı : 200°C - 480°C
Çıkış Voltajı: 24V AC

KOD: 938 A

68,00 \$ / Adet

Lehim Temizleme Teli

Altlıklı

KOD: ZD-11 W 6,50 \$ / Adet

Lehim Temizleme Teli

KOD: ZD-12 W 4,50 \$ / Adet

Lehim Alma Teli

Ürün No	Genişlik	Fiyatı / \$
ZD-180	1,00 mm	1,80 \$
	1,50 mm	2,00 \$
	2,00 mm	2,25 \$
	3,00 mm	3,00 \$

SOLOMON SET VE KALEM HAVYALAR

40W Kalem Havya



KOD: SR965 \$ / Adet

30W Kalem Havya



KOD: SR968 \$ / Adet

SL-20/30 Yedek Havya



KOD: SL20NI \$ / Adet

Metal Gövdeli Lehim Pompası



KOD: SH-817 \$ / Adet

Dijital Isı Ayarlı Havya 24V/48W



KOD: SL30 \$ / Adet

Havya Uçları (G1-G2) (621-623)



SL 20/30 Havya Ucu 965-968 Havya Ucu

SL 20/30 \$ / Adet

965/968 \$ / Adet

Analog Isı Ayarlı Havya 60 W / 480 °C



KOD: SS-306 90,00 \$ / Adet

Havya Temizleme Süngeri



KOD: HS-15 1,10 \$ / Adet

236 ESD İstasyonlu Havya



90W, ESD Gövde

KOD: 236 ESD 150,00 \$ / Adet

SONAR TABANCA HAVYALAR

100W Sonar Tabanca Havya



KOD: HS-01 52,00 \$ / Adet

100W Sonar Tabanca Havya Ucu

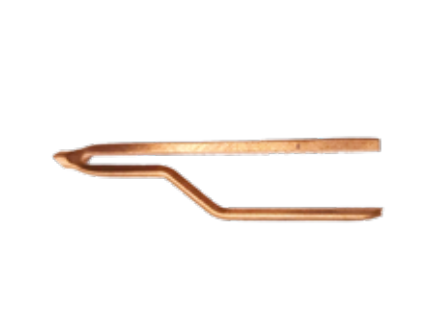

KOD: HS-03 4,00 \$ / Adet

250W Sonar Tabanca Havya



KOD: HS-02 145,00 \$ / Adet

ÖLÇÜ ALETLERİ



www.konsangroup.com

UNI-T®



UNI-T® ÖLÇÜ ALETLERİ



MODEL	FİYAT / \$
UT07B-EU	18,00 \$
A12T	22,00 \$
A25M	140,00 \$
A37	205,00 \$
A61	24,00 \$
UT12D	11,00 \$
UT12E	21,00 \$
UT12M	24,00 \$
UT15C	64,00 \$
UT18D	94,00 \$
UT22B-EU	22,00 \$
UT17B PRO	160,00 \$
UT33A+	30,00 \$
UT33B+	20,00 \$
UT33C+	23,00 \$
UT33D+	21,00 \$
UT39A+	36,00 \$
UT39C+	46,00 \$
UT39E	64,00 \$
UT58D	72,00 \$
UT58A	60,00 \$
UT58C	70,00 \$
UT58E	121,00 \$
UT61B+	110,00 \$
UT61C	81,00 \$
UT61D+	120,00 \$
UT61E+	190,00 \$
UT71A	270,00 \$
UT71B	330,00 \$
UT71C	380,00 \$
UT71D	460,00 \$
UT71E	520,00 \$
UT81C	550,00 \$
UT89X	50,00 \$
UT89XD	56,00 \$
UT89XE	103,00 \$
UT107	60,00 \$
UT116C	40,00 \$
UT118B	60,00 \$

MODEL	FİYAT / \$
UT120A	31,00 \$
UT120C	38,00 \$
UT123	24,00 \$
UT123D	40,00 \$
UT125C	40,00 \$
UT136C+	46,00 \$
UT139C	96,00 \$
UT151C	62,00 \$
UT171A	345,00 \$
UT171B	500,00 \$
UT181A	700,00 \$
UT191E	117,00 \$
UT191T	150,00 \$
UT195M	250,00 \$
UT195DS	300,00 \$
UT200A	36,00 \$
UT201+	42,00 \$
UT202+	48,00 \$
UT202A+	44,00 \$
UT203+	84,00 \$
UT204+	94,00 \$
UT205E	92,00 \$
UT206B	120,00 \$
UT208B	200,00 \$
UT210D	110,00 \$
UT210E	110,00 \$
UT211B	220,00 \$
UT216C	180,00 \$
UT216D	260,00 \$
UT219E	180,00 \$
UT219DS	270,00 \$
UT220	120,00 \$
UT221	200,00 \$
UT222	400,00 \$
UT230B-EU	44,00 \$
UT243	600,00 \$
UT251C	250,00 \$

MODEL	FİYAT / \$
UT253A	760,00 \$
UT256B	140,00 \$
UT261A	90,00 \$
UT265B	790,00 \$
UT267B	1.400,00 \$
UT276A+	630,00 \$
UT278A+	750,00 \$
UT281C	190,00 \$
UT281E	250,00 \$
UT300A+	28,00 \$
UT300S	28,00 \$
UT300R	26,00 \$
UT301C+	104,00 \$
UT302C+	130,00 \$
UT303C+	220,00 \$
UT305S	360,00 \$
UT305R	33,00 \$
UT306A	34,00 \$
UT306C	28,00 \$
UT309A	120,00 \$
UT309E	148,00 \$
UT315A	700,00 \$
UT320D	34,00 \$
UT321	140,00 \$
UT322	160,00 \$
UT325	170,00 \$
UT330THC	80,00 \$
UT330T	48,00 \$
UT330TH	70,00 \$
UT331+	86,00 \$
UT332+	120,00 \$
UT333	36,00 \$
UT333BT	42,00 \$
UT333S	44,00 \$
UT337A	130,00 \$
UT343A	150,00 \$
UT343E	300,00 \$
UT334A	130,00 \$



UNI-T® ÖLÇÜ ALETLERİ



MODEL	FİYAT / \$
UT343D	180,00 \$
UT352	250,00 \$
UT353	34,00 \$
UT353BT	46,00 \$
UT362	310,00 \$
UT363	34,00 \$
UT363BT	42,00 \$
UT363S	64,00 \$
UT372	150,00 \$
UT373	40,00 \$
UT377A	40,00 \$
UT381A	110,00 \$
UT383	34,00 \$
UT383BT	44,00 \$
UT383S	52,00 \$
UT385	290,00 \$
UT387A	60,00 \$
LM40T	68,00 \$
LM50A	43,00 \$
LM60T	74,00 \$
LM70A	60,00 \$
LM100A	81,00 \$
LM120A	110,00 \$
LM320A	56,00 \$
LM570R-I	80,00 \$
UT501A	124,00 \$
UT502A	220,00 \$
UT505B	540,00 \$
UT511	240,00 \$
UT513A	650,00 \$
UT516B	2.600,00 \$
UT521	312,00 \$
UT522	344,00 \$
UT526	370,00 \$

MODEL	FİYAT / \$
UT533	400,00 \$
UT582+	220,00 \$
UT603	88,00 \$
UT612	280,00 \$
UT620A	870,00 \$
UT658	16,00 \$
UT658A	18,00 \$
UT658B	13,00 \$
UT658DUAL	26,00 \$
UT658LOAD	40,00 \$
UT665	150,00 \$
UT681C	26,00 \$
UT681HDMI	38,00 \$
UT682	64,00 \$
UT682D	36,00 \$
UT691-01	35,00 \$
UT691-10	50,00 \$
UT692G	70,00 \$
UT693D	110,00 \$
UT701	410,00 \$
UT705	520,00 \$
UT714	1.260,00 \$
UT715	1.260,00 \$
UT801	220,00 \$
UT8802E	360,00 \$
UT8803E	460,00 \$
UT8804E	740,00 \$
UT8805E	1.380,00 \$
UTi165A	820,00 \$
UTi165K	900,00 \$
UTi220K	930,00 \$
UTi165A+	840,00 \$
UTD1025CL	850,00 \$
UTD1025DL	1.050,00 \$

MODEL	FİYAT / \$
UTD1050CL	840,00 \$
UTD1050DL	1.150,00 \$
UTD1102C	1.500,00 \$
UTD1202C	2.300,00 \$
UTD2052CL	640,00 \$
UTD2102CEX	720,00 \$
UPO3154E	3.200,00 \$
UPO3252E	2.800,00 \$
UTP1306	290,00 \$
UTG1010A	500,00 \$
UTG2025A	920,00 \$
UTG2122B	1.400,00 \$
UT-L17	10,00 \$
UT-L21	6,00 \$
UT-L20	5,20 \$
UT-L27	11,00 \$
UT-L35	84,00 \$
UT-T04	52,00 \$
UT-T07	52,00 \$
UT-H05	38,00 \$
UT-P04	28,00 \$
UT-P05	36,00 \$
UT-C02B	16,00 \$
UT-C01	20,00 \$
UT-CS09C	115,00 \$
UT-CS09D	128,00 \$
LM40Mi	54,00 \$
LM60Mi	60,00 \$
UT-362H	320,00 \$
UT-T10K	10,00 \$
UT-T07	52,00 \$
UT-T04	52,00 \$
UT-L90	17,00 \$
UT-L27	11,00 \$

ÖLÇÜ ALETLERİ

MS-6812 KABLO TAKİP CİHAZI



Fiyatı (\$) **23,00 \$**

Ton frekansı : 1.5KHz
Frekans Aralığı : 100Hz-300KHz
Batarya : 2 x 9V 6F22

TES 3014 PENSAMPERMETRE



Fiyatı (\$) **75,00 \$**

Kategori: CAT II 1000V, CAT III 600V
Kapasitans ölçümü 2000µF.
Değişken frekanslı sürücü VFD gerilimi ve Akım ölçümü.
ACA: 600A (3013), 1000A (3014)

M-266 PENSAMPERMETRE



Fiyatı (\$) **16,00 \$**

Ac Akım : 20-200-1000A ± %3.0
Ac Voltaj : 20-200-750V(600V) ± %1.0
Dc Voltaj : 200M-2-20-200-1000V ± %0.8
İzolasyon : 20m-2000mΩ±%2.0~4.0
OHM : 200-20k-2MΩ ± %1.0

VC-850 3 FAZ SIRASI TEST ALETİ



Fiyatı (\$) **55,00 \$**

Yüksek güvenilirlik
200VAC' den 600VAC' ye kadar geniş bir 3 faz güç kaynağı yelpazesini test edebilir.

6890-63 62DC / 16-380V FAZ KONTROL KALEMİ



Fiyatı (\$) **7,00 \$**

62DC Genel Amaçlı Voltaj tester
16V-380V arası

6885-48 M VOLTAJ TEST KALEMİ



Fiyatı (\$) **4,60 \$**

DC Voltaj : Temaslı 70-250 V
AC Voltaj : Temasız 70 – 10.000 V
Polarite Kontrolü : 1.2 VDC - 36 VDC
Süreklilik Testi 0=5 MΩ, L=0-50 MΩ, H=0-100 MΩ
Led ve Sesli İkaz : Var Mikro Dalga Kontrolü : Var

6878-28 DCY 25 DİJİTAL KONTROL KALEMİ



Fiyatı (\$) **2,15 \$**

12-500 V aralığından AC-DC Voltaj ölçümüyle toprak ve AC kablo kopukluklarını tespit eder.
Voltaj bölünmeli dijital ekran.

MAS 830 L DİJİTAL MULTİMETRE



Fiyatı (\$) **15,00 \$**

Direnç : 200Ω - 2KΩ - 20KΩ - 200KΩ - 2MΩ (± % 1.0)
Diyot : 3.0 V / 0.8 mA
Sesli ikaz : EVET
Ağırlık : 170 g
DC Voltaj : 200mV / 2V / 20V / 200V / 600V (± %0.8)
AC Voltaj : 200V - 600V (± %1.5)

M 832 DİJİTAL MULTİMETRE



Fiyatı (\$) **7,50 \$**

DC Voltaj : 200M-2-20-200-1000V ± %0.5
AC Voltaj : 200-750V ± %1
DC Akım : 2m 20m 200m-10A± %1.3
OHM : 200-2k-20k-200k-2MΩ±%0.8
DİOT Test : 3.0V/0.8mA
Transistor : hfe0~1000
Sesli ikaz : Var
Sinyal çıkışı : 50Hz Kare dalga
Ağırlık : 170g, Batarya:6F22,9Vx1

ÖLÇÜ ALETİ PROPLARI



T-70 Silikon Prop
Fiyatı (\$) 100cm
12,00 \$



T-87 Prop
Fiyatı (\$) 100cm
3,20 \$



T-81 Osiloskop Probu
Fiyatı (\$) 103 cm
25,00 \$

KS 268 ANALOG ÖLÇÜ ALETLERİ



Fiyatı (\$) **32,00 \$**

Ekran : İbrelili, Analı skala
DC Voltaj Kademe : 0.3V, 3V, 12V, 30V, 120V, 300V, 1200V
Tanım : Analog ölçü aleti
DC Voltaj : 1200V
AC Voltaj Kademe : 50V, 120V, 300V, 1200V
Direnç : 1000 mΩ
DC Akım Kademe : 3mA, 30mA, 300mA, 12A
Diod Testi, Transistor Testi, DC Akım : 12 Amper

İZELTAŞ KONTROL KALEMİ



KP 3458
Fiyatı (₺) 190 mm
201,25 ₺

KP 3459
Fiyatı (₺) 135 mm
157,50 ₺

BANT, SPREY VE SICAK HAVA TABANÇALARI



www.konsangroup.com



Coroplast



KSN® ERIYEN BANTLAR

İTHALATIMIZ



Esnek yapısı sayesinde kullanımı rahat olup, kabloların ek yerlerine yapıştırdıktan kısa bir süre sonra kendiliğinden eriyerek sızdırmazlık sağlamaktadır.

ÜRÜN KODU	AÇIKLAMA	KOLİ ADEDİ	FİYAT (\$)
BANT 006	19 mm x 0.8 mm x 8 mt Eriyen Bant	60	2,00 \$
BANT 007	50 mm x 0.8 mm x 8 mt Eriyen Bant	24	5,00 \$

GLOBE İZOLE BANTLAR



ÜRÜN KODU	AÇIKLAMA	KOLİ AD.	FİYAT
GLOBE	0,13 mm x 19 mm x 9,1 mt	500	☎
GLOBE SARI / YEŞİL	0,13 mm x 19 mm x 9,1 mt	500	
GLOBE	0,13 mm x 50 mm x 25 mt	60	

ÇİFT TARAFLI BANTLAR



ÜRÜN KODU	CİNSİ	ÖLÇÜ (mm)	BİRİM FİYAT ADET (₺)
ÇTBANT-155	Çift Taraflı Bant	10 mm x 10 mt	35,00 ₺
ÇTBANT-156	Çift Taraflı Bant	12 mm x 10 mt	40,00 ₺
ÇTBANT-157	Çift Taraflı Bant	19 mm x 10 mt	60,00 ₺
ÇTBANT-158	Çift Taraflı Bant	19 mm x 25 mt	155,00 ₺
ÇTBANT-159	Çift Taraflı Bant	25 mm x 10 mt	80,00 ₺
ÇTBANT-160	Çift Taraflı Bant	30 mm x 10 mt	96,00 ₺
ÇTBANT-162	Çift Taraflı Bant	38 mm x 10 mt	120,00 ₺
ÇTBANT-163	Çift Taraflı Bant	50 mm x 10 mt	160,00 ₺
ÇTBANT-164	Yapışkanlı Alüminyum Bant	50 mm x 30 mt	4,00 \$

Coroplast TÜYLÜ ve TÜYSÜZ BEZ BANTLAR



ÜRÜN KODU	CİNSİ	ÖLÇÜ (mm)	BİRİM FİYAT ADET (€)
TBBANT-151	Tüysüz Bant	9 mm x 15 mt	1,30 €
TBBANT-152	Tüysüz Bant	19 mm x 15 mt	1,50 €
TBBANT-153	Tüysüz Bant	19 mm x 25 mt	2,45 €
TBBANT-154	Tüylü Bant	19 mm x 15 mt	1,50 €
TBBANT-155	Tüysüz Bant	50 mm x 25 mt	7,60 €
TBBANT-156	Beyaz Bez Bant (Yerli)	19 mm x 25 mt	135,00 ₺
TBBANT-157	Beyaz Bez Bant (Yerli)	25 mm x 25 mt	185,00 ₺

TEFLON BANTLAR



ÜRÜN KODU	CİNSİ	ÖLÇÜ (mm)	BİRİM FİYAT ADET
RESIFLON	Teflon Bant Resiflon	12 x 0,076 x 12	0,48 €
CARTEL	Teflon Bant Resiflon	12 x 0,076 x 12	0,32 \$

SICAK HAVA TABANÇALARI

CAT Sıcak Hava Tabancası



CAT-202
 Güç : 2000 W
 Isı : 350 - 550 °C
 Devir : 300-500 l/dak

KOD: CAT-202 32,00 \$ / Adet

STEINEL HL 1620 S - 1600 WATT



STEINEL

HL 1620 S
 Güç : 1600 W
 Isı : 300 - 500 °C
 Hava : 240-450 lt/dk.
 Kablo : 2,2 mt
 Ebat : 252x85,5x200 mm
 Ağırlık : 670 gr

KOD: HL 1620 S 55,00 € / Adet



SİLİKON TABANÇALARI ve MUM SİLİKONLAR

Silikon Tabancası 55 W



55 W 13,00 \$ / Adet

Silikon Tabancası 80 W



80 W 28,00 \$ / Adet

Silikon Tabancası 100 W



100 W 53,00 \$ / Adet

Mum Silikon, 8 - 11 mm



Beyaz	11,00 \$ / Kg
Siyah	14,00 \$ / Kg

HAWCON® SPREY ÇEŞİTLERİ

İMALATIMIZ



HAWCON®



HW 01 - Yağsız Kontak Spreyi
Degreaser Cleaner

200 ml.

Kirli ve yıpranabilir yüzeyler, elektronik bağlantıları, fişler, voltaj regülatörleri, akım düzenleyiciler, telefon aksamı, uzaktan kumanda cihazları, bujiler ve voltaj ölçer cihazların temizliğinde kullanılabilir.

Adet / \$

3,25 \$



HAWCON®



HW 02 - Yağlı Kontak Spreyi
Contact Cleaner

200 ml.

Her türlü mekanik ve elektronik parçaları temizler, yağlar ve korur. Elektrik iletkenliğini artırır. Neme, toza ve paslanmaya karşı etkilidir.

Adet / \$

3,25 \$

PERFECTS SPREY ÇEŞİTLERİ

YETKİLİ BAYI

Yağlı Kontak Spreyi / Contact Cleaner



200 ml.

Her türlü mekanik ve elektronik parçaları temizler, yağlar ve korur. Elektrik iletkenliğini artırır. Neme, toza ve paslanmaya karşı etkilidir.

Adet / €

3,71 €

Yağsız Kontak Spreyi / Degreaser Cleaner



200 ml.

Kirli ve yıpranabilir yüzeyler, elektronik bağlantıları, fişler, voltaj regülatörleri, akım düzenleyiciler, telefon aksamı, uzaktan kumanda cihazları, bujiler ve voltaj ölçer cihazların temizliğinde kullanılabilir.

Adet / €

4,35 €

Köpük Temizleyici Sprey / Instant Cleaner



200 ml.

Tüm kalıcı kirleri, akıntıları, parmak izlerini temizleyen yoğun köpük. Seramikler, cam, ahşap ve plastik yüzeylerde, bilgisayarlarda, elektronik ürünlerde güvenle kullanılabilir.

Adet / €

3,92 €

Etiket Çıkarıcı Sprey / Label Remover



200 ml.

Bir artık bırakmaksızın etiketleri çıkarır. Kullanımı hızlı ve etkilidir. El tipi fırça uygulayıcısı vardır.

Adet / €

4,88 €

Dondurucu Sprey / Freeze Spray



200 ml.

Cihazların ısıya karşı hassas olan devrelerinde elektrikle ilgili oluşan hataları bulmada çabuk donarak -50°C'ye kadar etkilidir. Lehim sırasında parçaları korur aynı zamanda yapışan sazık, artıklar ve mum yağını çıkarmada yardımcı olur.

Adet / €

15,90 €

Plastik 70 Silikon Sprey



400 ml.

Yüksek düzeyde izolasyon özelliğine sahip, saydam kaplama, akrilik reçine içermektedir. Ve sulandırılmıştır. Korumucu film gibi kaplar. Sıcaklık aralığı -70°C ile 100°C'dir.

KOD: 74313

28,00 € / Adet

FLU / Elektronik Kart Temizleyici (Fırçalı)



400 ml.

Baskılı devre kartlarının her açıdan mükemmel şekilde temizlenmesini sağlar. Her türlü kaynak tozunu temizler, geride atık bırakmaz, çabuk kurur. Yüksek derecede izolasyon direnci sağlar.

KOD: 82009

20,00 € / Adet

WD - 40 Pas Önleyici Sprey



200 ml.

Aletleri ve mekanikleri korozyondan korur. Yüksek nemli ve tuzlu (marin) çevrelerde kullanım için idealdir.

200 ml.

300,00 ₺ / Adet

WD - 40 Pas Önleyici Sprey



400 ml.

Aletleri ve mekanikleri korozyondan korur. Yüksek nemli ve tuzlu (marin) çevrelerde kullanım için idealdir.

400 ml.

450,00 ₺ / Adet

ANAHTAR VE SWITCH GRUBU























www.konsangroup.com



YERLİ ANAHTAR VE SWITCH ÇEŞİTLERİ



<p>Difaze Işıklı Anahtar</p>  <p>HWA-001 0,65 \$ / Ad.</p>	<p>Difaze Işıklı Klemensli Anahtar</p>  <p>4 Vidalı (16A) HWA-002 0,72 \$ / Ad.</p>	<p>Difaze Işıksız Anahtar</p>  <p>HWA-003 0,60 \$ / Ad.</p>	<p>Difaze Çift Tarafa Yaylı Asansör Şalteri</p>  <p>HWA-004 0,93 € / Ad.</p>
<p>İkili Işıklı Anahtar</p>  <p>HWA-005 0,80 \$ / Ad.</p>	<p>İkili Işıksız Anahtar</p>  <p>HWA-006 0,60 \$ / Ad.</p>	<p>Tekli Işıklı Anahtar</p>  <p>HWA-007 0,40 \$ / Ad.</p>	<p>Tekli Işıksız Anahtar</p>  <p>HWA-008 0,35 \$ / Ad.</p>
<p>Üçlü Işıklı Anahtar</p>  <p>HWA-009 1,40 \$ / Ad.</p>	<p>Üçlü Işıksız Anahtar</p>  <p>HWA-010 1,10 \$ / Ad.</p>	<p>Anh. Işıklı Topraklı Erkek Fiş</p>  <p>HWA-013 2,00 \$ / Ad.</p>	<p>İpli Switch</p>  <p>HWA-015 25,00 ₺ / Ad.</p>
<p>Çıt Çıt Anahtar</p>  <p>HWA-016 0,21 \$ / Ad.</p>	<p>16 A Düz Dolap Switch</p>  <p>HWA-019A 0,60 \$ / Ad.</p>	<p>16 A Ters Dolap Switch</p>  <p>HWA-019 0,60 \$ / Ad.</p>	<p>25 A Şofben Switch</p>  <p>HWA-020 0,75 \$ / Ad.</p>
<p>Uzun Paletli Micro Switch</p>  <p>HWA-170 0,48 \$ / Ad.</p>	<p>Paletsiz Micro Switch</p>  <p>HWA-170-0 0,48 \$ / Ad.</p>	<p>Uzun Makaralı Micro Switch</p>  <p>HWA-171 0,48 \$ / Ad.</p>	<p>Kısa Makaralı Micro Switch</p>  <p>HWA-172 0,48 \$ / Ad.</p>
<p>Monofaze Pompalı Şalter 20 A</p>  <p>HWA-021 175,00 ₺ / Ad.</p>	<p>Trifaze Pompalı Şalter 20 A</p>  <p>HWA-022 175,00 ₺ / Ad.</p>		

İTHAL ANAHTAR VE SWITCH ÇEŞİTLERİ

<p>İkili Işıklı Anahtar 6P</p>  <p>ON/OFF</p> <p>HWA-101 0,72 \$ / Ad.</p>	<p>İkili Işıksız Anahtar 4P</p>  <p>ON/OFF</p> <p>HWA-103 0,52 \$ / Ad.</p>	<p>Difaze Işıklı Anahtar 4P</p>  <p>ON/OFF</p> <p>HWA-104 0,50 \$ / Ad.</p>	<p>Difaze Işıklı Anahtar 6P</p>  <p>ON/OFF</p> <p>HWA-104A 0,70 \$ / Ad.</p>
<p>Körüklü Geniş Işıklı Anahtar 4P</p>  <p>ON/OFF</p> <p>HWA-104W 1,25 \$ / Ad.</p>	<p>Geniş Işıklı Anahtar 6P</p>  <p>ON/OFF/ON</p> <p>HWA-105 0,68 \$ / Ad.</p>	<p>Körüklü Geniş Işıksız Anahtar 6P</p>  <p>ON/OFF/ON</p> <p>HWA-108W 1,68 \$ / Ad.</p>	<p>Yaylı Geniş Işıksız Anahtar 6P</p>  <p>ON/OFF/ON</p> <p>HWA-110 0,70 \$ / Ad.</p>
<p>Geniş Anahtar Kılıfı</p>  <p>HWA-112 0,27 \$ / Ad.</p>	<p>Tekli Dar Işıklı Anahtar 3P</p>  <p>ON/OFF</p> <p>HWA-113 0,35 \$ / Ad.</p>	<p>Tekli Dar Işıksız Anahtar 2P</p>  <p>ON/OFF</p> <p>HWA-114 0,27 \$ / Ad.</p>	<p>Tekli Dar Işıksız Anahtar 3P</p>  <p>ON/OFF/ON</p> <p>HWA-115 0,41 \$ / Ad.</p>
<p>Mini Işıklı Anahtar 3P</p>  <p>ON/OFF</p> <p>HWA-118 0,35 \$ / Ad.</p>	<p>Mini Işıklı Anahtar 4P</p>  <p>ON/OFF</p> <p>HWA-119 0,38 \$ / Ad.</p>	<p>Mini Işıksız Anahtar 2P</p>  <p>ON/OFF</p> <p>HWA-120 0,16 \$ / Ad.</p>	<p>Mini Işıksız Anahtar 3P</p>  <p>ON/ON</p> <p>HWA-121 0,20 \$ / Ad.</p>
<p>Mini Işıksız Anahtar 4P</p>  <p>ON/OFF</p> <p>HWA-122 0,33 \$ / Ad.</p>	<p>Mini Işıksız Anahtar 3P</p>  <p>ON/OFF/ON</p> <p>HWA-123 0,27 \$ / Ad.</p>	<p>Yaylı Mini Işıksız Anahtar 3P</p>  <p>ON/OFF/ON</p> <p>HWA-123A 0,58 \$ / Ad.</p>	<p>Yaylı Mini Işıksız Anahtar 2P</p>  <p>ON/OFF</p> <p>HWA-124 0,27 \$ / Ad.</p>
<p>(S) Mini Işıksız Anahtar 2P</p>  <p>ON/OFF</p> <p>HWA-125B 0,15 \$ / Ad.</p>	<p>Orta Boy Işıklı Anahtar 4P</p>  <p>ON/OFF</p> <p>HWA-126 0,51 \$ / Ad.</p>	<p>Orta Boy Işıksız Anahtar 4P</p>  <p>ON/OFF</p> <p>HWA-127 0,38 \$ / Ad.</p>	<p>Yuvarlak Işıklı Anahtar 3P</p>  <p>ON/OFF</p> <p>HWA-131 0,35 \$ / Ad.</p>

İTHAL ANAHTAR VE SWITCH ÇEŞİTLERİ

<p>Yuvarlak Işıklı Anahtar 3P</p>  <p>12 V DC ON/OFF</p> <p>HWA-131A 0,38 \$ / Ad.</p>	<p>Yuvarlak Işıklı Anahtar 4P</p>  <p>ON/OFF</p> <p>HWA-131-4 0,54 \$ / Ad.</p>	<p>Körüklü Yuvarlak Işıklı Anh. 3P</p>  <p>ON/OFF</p> <p>HWA-131W 1,22 \$ / Ad.</p>	<p>Yuvarlak Işıksız Anahtar 2P</p>  <p>ON/OFF</p> <p>HWA-133A 0,28 \$ / Ad.</p>
<p>Yuvarlak Işıksız Anahtar 3P</p>  <p>ON/OFF/ON</p> <p>HWA-134 0,35 \$ / Ad.</p>	<p>Oval Işıklı Anahtar 3P</p>  <p>ON/OFF</p> <p>HWA-134B 0,35 \$ / Ad.</p>	<p>Oval Işıksız Anahtar 2P</p>  <p>ON/OFF</p> <p>HWA-134C 0,27 \$ / Ad.</p>	<p>(S) Mini Yuvarlak Işıklı Anh. 3P</p>  <p>ON/OFF</p> <p>HWA-134D 0,48 \$ / Ad.</p>
<p>(S) Mini Yuvarlak Işıksız Anh. 2P</p>  <p>ON/OFF</p> <p>HWA-134E 0,25 \$ / Ad.</p>	<p>Üçlü Işıklı Anahtar 9P</p>  <p>ON/OFF</p> <p>HWA-135 1,23 \$ / Ad.</p>	<p>Üçlü Işıksız Anahtar 9P</p>  <p>ON/OFF</p> <p>HWA-136 1,10 \$ / Ad.</p>	<p>Orta Boy Toggle Switch 2P</p>  <p>2 A ON/OFF</p> <p>HWA-149 0,58 \$ / Ad.</p>
<p>Metal Buton</p>  <p>10 mm</p> <p>HWA-179 0,25 \$ / Ad.</p>	<p>Metal Buton</p>  <p>16 mm</p> <p>HWA-180 0,36 \$ / Ad.</p>	<p>Plastik Buton</p>  <p>16 mm</p> <p>HWA-180A 0,36 \$ / Ad.</p>	<p>Düz Metal Buton (PBS28B-2)</p>  <p>19 mm</p> <p>HWA-182 2,50 \$ / Ad.</p>
<p>Yüksek Metal Buton</p>  <p>19 mm</p> <p>HWA-182H 2,50 \$ / Ad.</p>	<p>Plastik Buton (PBS33B)</p>  <p>12 mm</p> <p>HWA-184 0,58 \$ / Ad.</p>	<p>Kapak Switch</p>  <p>12 mm (Ters) Normalde Kapaklı Kontak</p> <p>HWA-187A 0,50 \$ / Ad.</p>	<p>Yaylı Buton Plastik 2P</p>  <p>HWA-191C 0,36 \$ / Ad.</p>



TOGGLE SWITCH

Kod	Açıklama	Ad. / \$
HWA-152S	ON/OFF 3P Vidalı 15A	2,80 \$
HWA-152-2S	ON/OFF 2P Vidalı 15A	2,40 \$
HWA-153S	ON/OFF/ON 3P Vidalı 15A	2,80 \$
HWA-155S	(ON)/OFF/(ON) 3P Vidalı Yaylı 15A	3,00 \$



























TOGGLE SWITCH

Kod	Açıklama	Ad. / \$
HWA-157S	ON/OFF 6P Vidalı 15A	3,75 \$
HWA-158S	ON/OFF/ON 6P Vidalı 15A	3,75 \$
HWA-159	(ON)/OFF/ON 6P Vidalı Yaylı	2,50 \$
HWA-160	(ON)/OFF/(ON) 6P Vidalı Yaylı	2,50 \$

BORN KLEMENS BANAN FİŞ VE KROKODİL ÇEŞİTLERİ

<p>Banan Jak (Cx-02)</p>  <p>HWA-238 0,14 \$ / Ad.</p>	<p>Banan Jak (Cx-03)</p>  <p>HWA-238A 0,19 \$ / Ad.</p>	<p>Banan Jak (Silikonlu)</p>  <p>HWA-238B 0,68 \$ / Ad.</p>	<p>Banan Jak (Kare)</p>  <p>HWA-238C 0,43 \$ / Ad.</p>
<p>Banan Jak (Üçgen)</p>  <p>HWA-238D 0,27 \$ / Ad.</p>	<p>Banan Jak (Korumalı Tip)</p>  <p>4 mm HWA-238E 0,72 \$ / Ad.</p>	<p>Born Klemens (Büyük Boy)</p>  <p>HWA-239 0,27 \$ / Ad.</p>	<p>Born Klemens (B. Boy Korumalı)</p>  <p>HWA-239A 0,57 \$ / Ad.</p>
<p>Born Klemens (B. Boy Korumalı)</p>  <p>Vida Bacaklı HWA-239B 0,57 \$ / Ad.</p>	<p>Born Klemens (Orta Boy)</p>  <p>HWA-240 0,23 \$ / Ad.</p>	<p>Born Klemens (Büyük Boy)</p>  <p>Şeffaf HWA-240B 0,36 \$ / Ad.</p>	<p>Born Klemens (Orta Boy)</p>  <p>Şeffaf HWA-240C 0,12 \$ / Ad.</p>
<p>Born Klemens 100A</p>  <p>HWA-260 671,00 ₺ / Ad.</p>	<p>Born Klemens 63A</p>  <p>HWA-261 424,00 ₺ / Ad.</p>	<p>Born Klemens 32A</p>  <p>HWA-262 354,00 ₺ / Ad.</p>	<p>Hirschmann Krokodil AK-25</p>  <p>HWA-263 9,30 € / Ad.</p>
<p>Timsah Ağızlı Krokodil</p>  <p>66 mm HWA-243 0,12 \$ / Ad.</p>	<p>Banan Jak Girişli Krokodil</p>  <p>HWA-243A 1,00 \$ / Ad.</p>	<p>Banan Jak Girişli Krokodil (4mm)</p>  <p>HWA-243C 2,80 \$ / Ad.</p>	<p>Kablolu Krokodil (Küçük Boy)</p>  <p>HWA-247 0,18 \$ / Ad.</p>
<p>Kablolu Krokodil (Büyük Boy)</p>  <p>HWA-247A 0,28 \$ / Ad.</p>	<p>İzoleli Krokodil (Orta Boy)</p>  <p>35 mm HWA-248A 0,08 \$ / Ad.</p>	<p>İzoleli Krokodil (Büyük Boy)</p>  <p>42,5 mm HWA-248B 0,10 \$ / Ad.</p>	<p>İzoleli Krokodil (2 mm)</p>  <p>HWA-243D 1,00 \$ / Ad.</p>

AKÜ MAŞALARI VE ŞASE PENSE ÇEŞİTLERİ

<p>Akü Takviye Pensesi</p>  <p>Bakır Kaplama</p> <p>HWA-380 250,00 ₺ / Ad.</p>	<p>Akü Takviye Pensesi</p>  <p>Kadyum Kaplama</p> <p>HWA-381 30,00 ₺ / Ad.</p>	<p>Akü Takviye Pensesi</p>  <p>PVC Cam Elyaf</p> <p>HWA-382 3,50 \$ / Tk.</p>	<p>Akü Takviye Pensesi</p>  <p>HWA-383 110,00 ₺ / Ad.</p>
<p>Akü Takviye Pensesi</p>  <p>HWA-384 160,00 ₺ / Tk.</p>	<p>Mini Akü Takviye Pensesi</p>  <p>Bakır Kaplama</p> <p>HWA-385 25,00 ₺ / Ad.</p>	<p>Akü Pensesi (Orta Boy)</p>  <p>Kalay Kaplama</p> <p>HWA-386 0,25 \$ / Ad.</p>	<p>Bakır Kaplı Akü Pensesi</p>  <p>HWA-387 4,00 \$ / Tk.</p>
<p>Bakır Kaplı Maşa 13 cm</p>  <p>HWA-388 1,00 \$ / Ad.</p>	<p>Komple İzoleli Orta Boy</p>  <p>HWA-244A 0,40 \$ / Ad.</p>	<p>200A Topraklama Şase Pensesi</p>  <p>HWA-390 20,00 \$ / Ad.</p>	<p>400A Topraklama Şase Pensesi</p>  <p>HWA-391 32,00 \$ / Ad.</p>
<p>600A Topraklama Şase Pensesi</p>  <p>HWA-392 48,00 \$ / Ad.</p>	<p>300A Şase Pensesi</p>  <p>HWA-389 6,00 \$ / Ad.</p>	<p>500A Şase Pensesi</p>  <p>HWA-389A 8,50 \$ / Ad.</p>	<p>Normal Tip Akü Kutup Başı</p>  <p>HWA-393 200,00 ₺ / Ad.</p>
<p>Marin Tip Akü Kutup Başı</p>  <p>HWA-394 175,00 ₺ / Ad.</p>	<p>Kelebek Tip Akü Kutup Başı</p>  <p>HWA-397 175,00 ₺ / Ad.</p>	<p>Man Tipi Akü Kutup Başı</p>  <p>HWA-396 165,00 ₺ / Ad.</p>	<p>Kurşun Tip Akü Kutup Başı</p>  <p>HWA-395 3,50 \$ / Ad.</p>
<p>Kutup Başı Kapşon (Siyah)</p>  <p>HWA-398 42,00 ₺ / Ad.</p>	<p>Kutup Başı Kapşon (Kırmızı)</p>  <p>HWA-399 42,00 ₺ / Ad.</p>	<p>Metal Sinyal Lambası (8 mm)</p>  <p>12V - 24V - 220V</p> <p>HWA-225 0,60 \$ / Ad.</p>	<p>Sinyal Lambası (10 mm)</p>  <p>220V</p> <p>HWA-227 0,29 \$ / Ad.</p>

FUSE YUVA ve CAM SİGORTALAR

İthal Fuse Sigorta Yuvası			
			
5 x 20mm		6 x 30mm	
KOD: HWS-236	1,15 \$ / Adet	KOD: HWS-236	1,35 \$ / Adet

Yerli Fuse (5x20mm)	
	
KOD: HWS-237	35,00 ₺ / Adet

Kablolu Sigorta Yuvası (5x20)(6x30) ÇİN			
			
5 x 20mm	6 x 30mm		
KOD: HWS-237C	0,25 \$ / Adet	HWS-237C-2	0,30 \$ / Adet

Fuse Sigorta Yuvası (5x20mm)	
	
12mm / 13mm	
HWS-235A	0,35 \$ / Ad.

Fuse Sigorta Yuvası (6x30mm)	
	
14mm	
HWS-236	0,40 \$ / Ad.

Oto Tip Kablolu Sigorta Yuvası (Bıçak Tip)	
	
KOD: HWS-237D	0,90 \$ / Adet

Oto Tipi Bıçak Sigorta (Küçük Boy)	
	1 A 2 A 3 A 4 A 5 A 7,5 A 10 A 15 A 20 A 25 A 30 A 40 A
ÇİN Fiyatı	1,50 ₺ NET / Adet

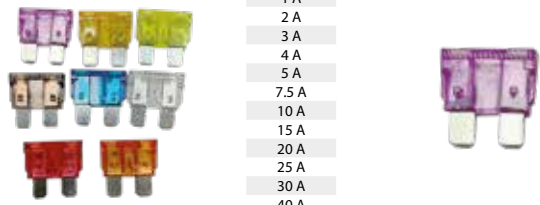
Oto Tipi Bıçak Sigorta (Standart)	
	1 A 2 A 3 A 4 A 5 A 7,5 A 10 A 15 A 20 A 25 A 30 A 40 A
ÇİN Fiyatı	2,00 ₺ NET / Adet

Oto Tipi Bıçak Sigorta (Büyük Boy)	
	20 A 30 A 40 A 50 A 60 A 80 A 100 A
Fiyatı	14,00 ₺ NET / Adet



HAWCON Cam Sigorta (5x20)					
0.050 MA	250V	0.5 A	250V	7 A	250V
0.100 MA	250V	1 A	250V	8 A	250V
0.150 MA	250V	1.2 A	250V	9 A	250V
0.200 MA	250V	1.6 A	250V	10 A	250V
0.250 MA	250V	2 A	250V	15 A	250V
0.315 MA	250V	2.5 A	250V	20 A	250V
0.400 MA	250V	3.15 A	250V	25 A	250V
0.500 MA	250V	4 A	250V	30 A	250V
0.630 MA	250V	5 A	250V		
0.750 MA	250V	6 A	250V		
0.800 MA	250V	6.3 A	250V		
Fiyatı			0,60 ₺ NET / Adet		

HAWCON Cam Sigorta (6x30)			
0.5 A	250V	7 A	250V
1 A	250V	8 A	250V
1.2 A	250V	9 A	250V
1.6 A	250V	10 A	250V
2 A	250V	15 A	250V
2.5 A	250V	20 A	250V
3.15 A	250V	25 A	250V
4 A	250V	30 A	250V
5 A	250V		
6 A	250V		
6.3 A	250V		
Fiyatı		0,80 ₺ NET / Adet	



SATIŞ KOŞULLARI

Fiyat listemiz brüt olup, aşağıda belirtilen şartlarda satış yapılmaktadır.

- 1 - Döviz cinsinden fiyatlar sevkiyat anındaki merkez bankası efektif satış kuru esas alınarak fatura edilecektir.*
- 2 - Ödemeler 90 günlük vadeye göre, fatura tarihinden itibaren maksimum 30 gün içinde çek ile tahsil edilecektir.*
- 3 - Malzeme sevkiyatı yapıldıktan sonra ödeme ve iskonto şekillerinde değişiklik yapılamaz.*
- 4 - Yıl sonunda cari hesapların mümkün olduğu kadar sıfırlanması konusunda gerekli hassasiyetin gösterilmesi,*
- 5 - Firmamız haber vermeksizin fiyatları değiştirme hakkını saklı tutar.*
- 6 - Firmamız katalogun basımından kaynaklanan bilgi ve fiyat yanlışlıklarını değiştirme hakkına sahiptir.*
- 7 - Fiyatlarımıza KDV dahil değildir.*

BANKA HESAP NUMARALARIMIZ;

Konsan Elektroteknik Sanayi ve Tic. Ltd. Şti.

BANKA	ŞUBE ve KODU	HESAP NO.	IBAN NO.
T. İŞ BANKASI	GALATA / 1021	9292 24	TR27 0006 4000 0011 0210 9292 24
VAKIFBANK	KARAKÖY / S00037		TR23 0001 5001 5800 7314 9702 21
GARANTİ BANKASI	GALATA / 67	6200538	TR48 0006 2000 0670 0006 2005 38
HALKBANK	BANKALAR CAD. / 0136	10260124	TR68 0001 2009 1360 0010 2601 24
YAPI KREDİ BANKASI	BANKALAR CAD. / 616	91967120	TR02 0006 7010 0000 0091 9671 20
ZİRAAT BANKASI	İSTANBUL ŞB. / 129	65133850-5001	TR80 0001 0001 2965 1338 5050 01
KUVEYTTÜRK	KARAKÖY / 52	97382432	TR84 0020 5000 0973 8243 2000 01

KSN®

Kaliteyi Seçme Nedeniniz...

KONSAN®
elektroteknik
san. ve tic. ltd. şti.

Merkez

Okçumusa Cad. Menevşe Han No: 22/66-67

Karaköy - İSTANBUL

Tel : (0212) 253 00 39 - 256 52 66 - 237 05 41

Faks : (0212) 256 52 65

İmes Şb.

İmes Sanayi Sitesi A Blok 108 Sk. No: 4

Dudullu / Ümraniye - İSTANBUL

Tel: (0216) 314 03 70

Perpa Şb.

Perpa Tic. Mrk. A Blok Kat: 5 No: 108

Okmeydanı - İSTANBUL

Tel: (0212) 320 31 50 - 51 - 52

Depo

Y.Dudullu Mah. Kerem Sk. No:10

Dudullu / Ümraniye - İSTANBUL

Tel: (0216) 314 03 71

E-mail:

info@konsangroup.com

muhassebe@konsangroup.com



JURKAB®



konsangroup.com

* Her türlü yazım-basım hatalarından kaynaklanan farklılıklardan KONSAN ELEKTROTEKNİK LTD. ŞTİ. firması sorumlu tutulamaz.
* Önceden haber vermeksizin fiyat değişikliği yapma hakkımız saklıdır.



/konsangroup.com